

Bugs World 3

Name: _____

Unit 1 MIXED-ABILITY WORKSHEET 1

Class: _____

1 Circle nine colours. Colour and write.

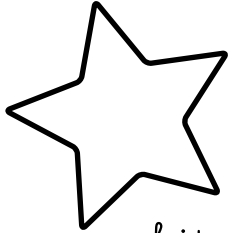

white

e	o	n	b	y	c	r	e	d
a	o	b	t	w	k	w	f	h
y	e	l	l	o	w	h	g	o
r	q	u	d	f	h	i	j	r
p	x	e	m	p	p	t	w	a
i	g	c	c	g	r	e	e	n
n	t	b	l	a	c	k	v	g
k	h	s	p	u	r	p	l	e
c	f	b	r	o	w	n	y	w

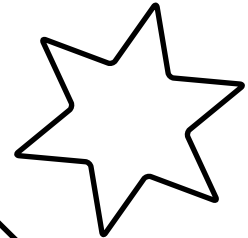
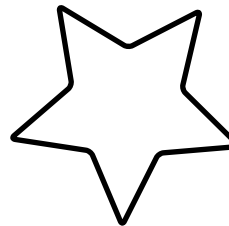
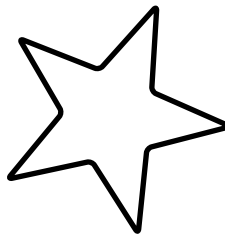
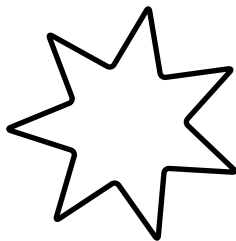
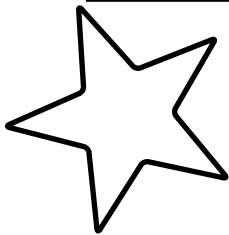
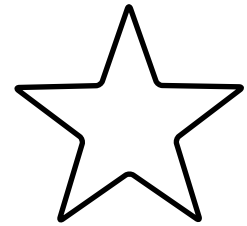
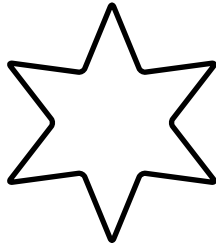
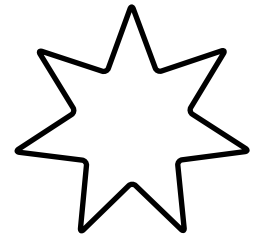

2 Write.

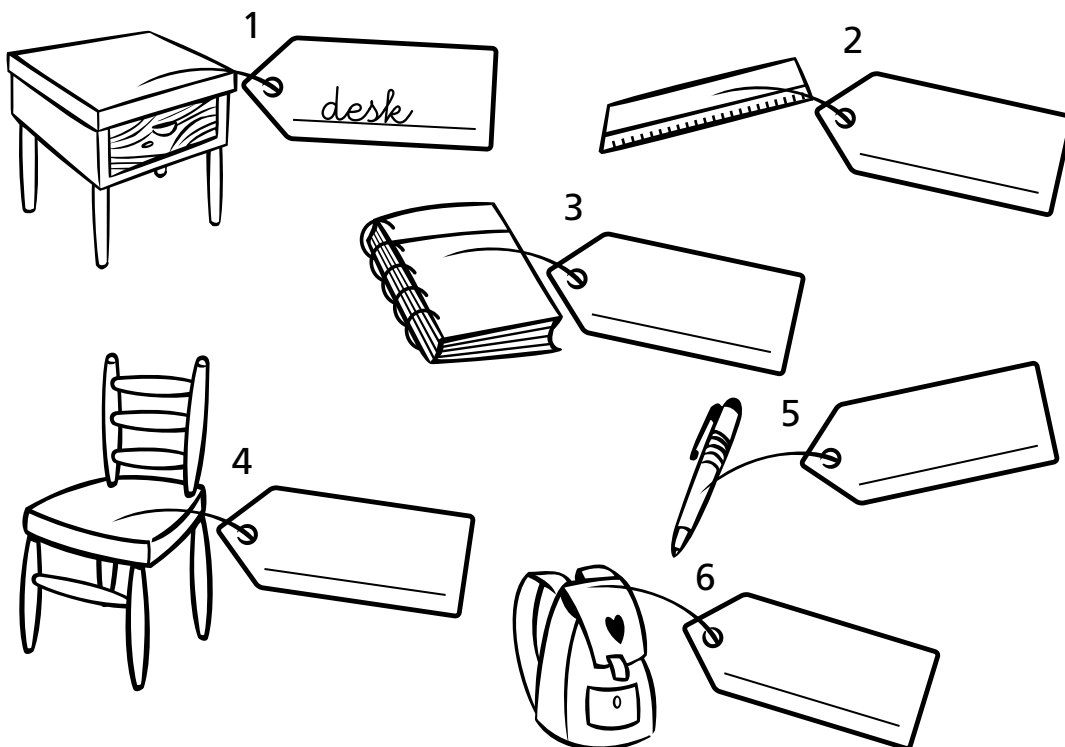

Bugs World 3

Name: _____

Unit 1 MIXED-ABILITY WORKSHEET 2

Class: _____

1 Count, read and circle true (T) or false (F).

- | | | |
|----------------------|-----|---|
| 1 three pencils | (T) | F |
| 2 five rulers | T | F |
| 3 six pens | T | F |
| 4 ten rubbers | T | F |
| 5 eight pencil cases | T | F |
| 6 two scissors | T | F |
| 7 four notebooks | T | F |



2 Colour, read and write.

* blue ▲ yellow □ white ● purple X green ○ black + red

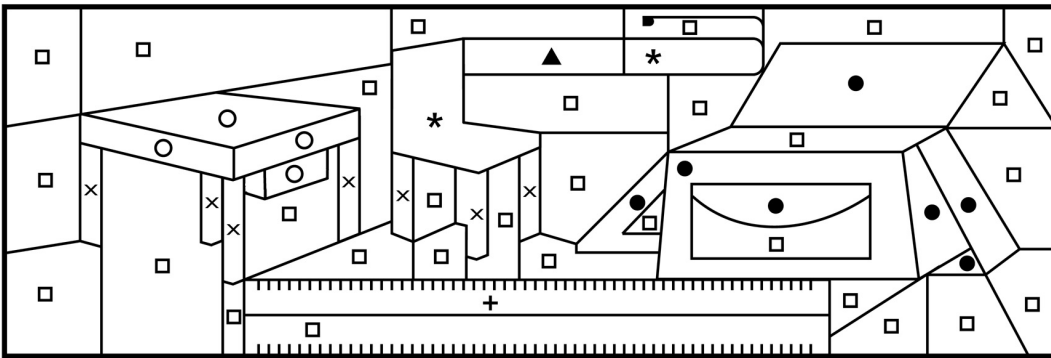

1 What is it? It's blue and yellow. It's a pen.

2 What is it? It's green and black. It's a _____

3 What is it? It's white and red. It's a _____

4 What is it? It's purple and white. It's a _____

5 What is it? It's blue and green. It's a _____

Bugs World 3

Name: _____

Class: _____

Unit 1 MIXED-ABILITY WORKSHEET 3

1 Draw. Circle the answer.

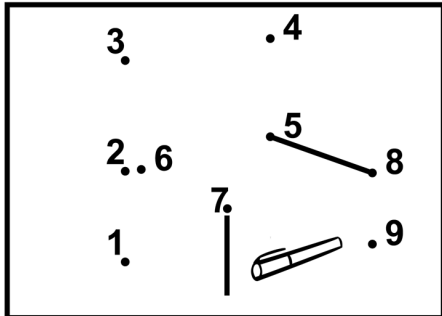

1 Where's the pen?

on
It's _____ the chair.
under

2 Where's the ruler?

in
It's _____ the school bag.
on

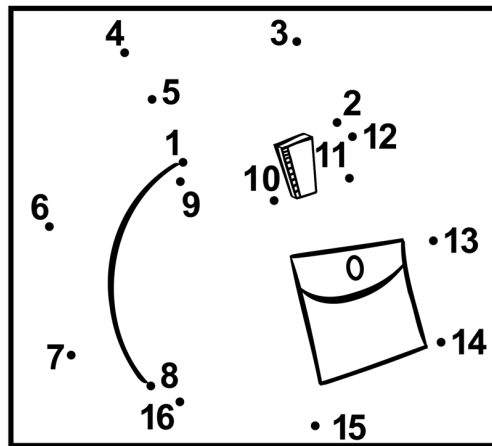

2 Look and write.

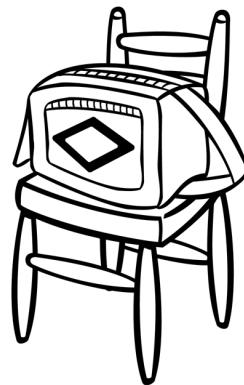
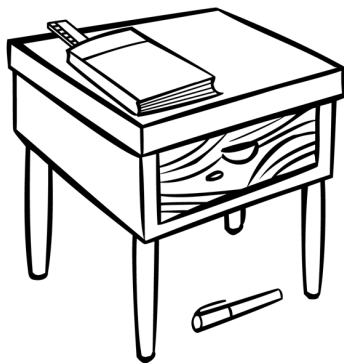

1 Where's the pen? It's under the desk.

2 Where's the ruler? It's _____

3 Where's the school bag? It's _____

4 Where's the notebook? It's _____

Bugs World 3

Name: _____

Unit 1 MIXED-ABILITY WORKSHEET 4

Class: _____

1 Colour, read and match.

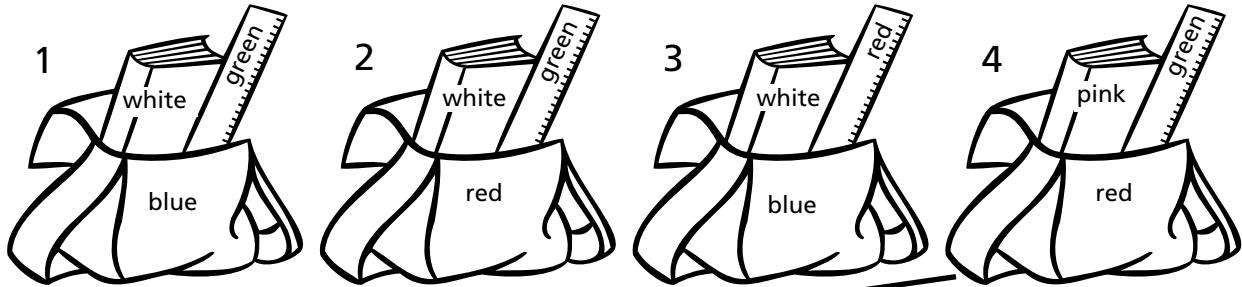

Sam

Susan

Wendy

Mark

a I'm Susan. My school bag is red. My ruler is green and my book is pink.

b I'm Mark. My school bag is blue. My ruler is green and my book is white.

c I'm Sam. My school bag is red. My ruler is green and my book is white.

d I'm Wendy. My school bag is blue. My ruler is red and my book is white.

2 Look and write.

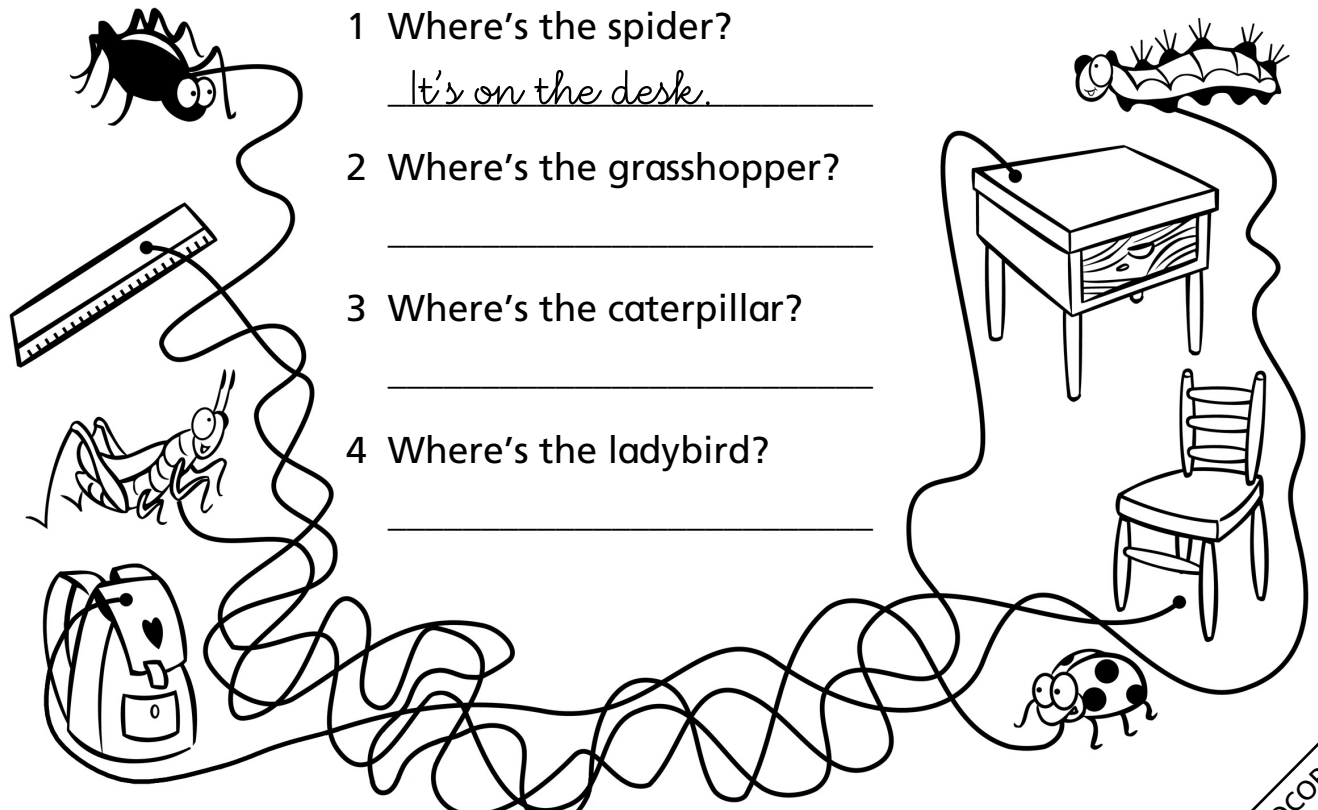

1 Where's the spider?
It's on the desk.

2 Where's the grasshopper?

3 Where's the caterpillar?

4 Where's the ladybird?

Bugs World 3

Name: _____

Unit 1 MIXED-ABILITY WORKSHEET 5

Class: _____

1 Write.



1 hamster



2 _____



3 _____

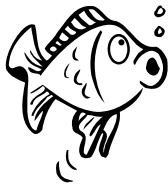

4 _____



5 _____



6 _____

2 Read, draw and colour.



This is my pet dog.
It's brown and black.

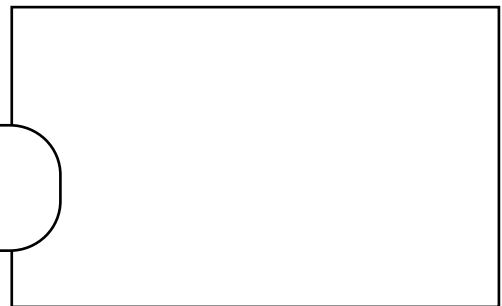

This is my pet
tortoise. It's green
and black.



This is my pet fish. It's
orange, red and yellow.



Bugs World 3

Name: _____

Unit 1 MIXED-ABILITY WORKSHEET 6

Class: _____

1 Read, look and circle true (T) or false (F).

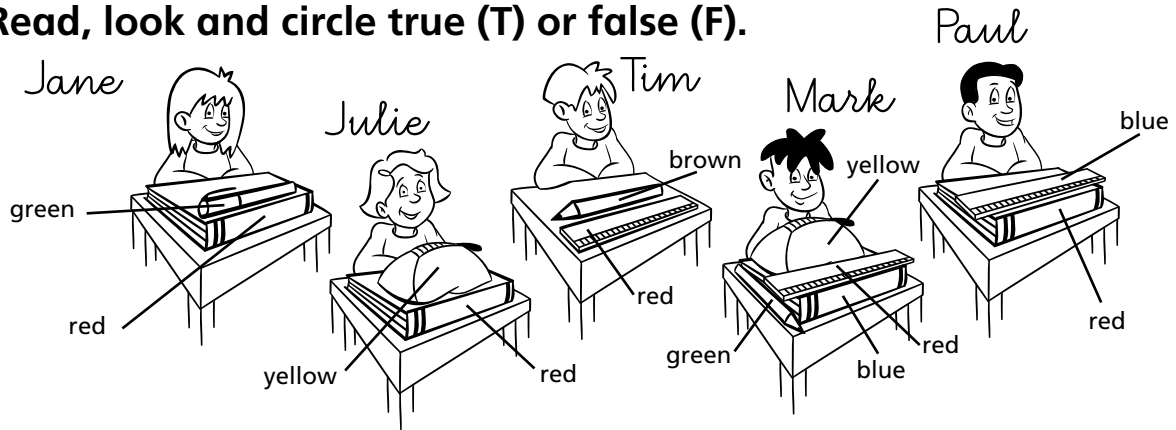

1 T I'm Jane. My pen is green
F and my book is orange.

2 T I'm Julie. My book is red
F and my pencil case is yellow.

3 T I'm Tim. My pencil is brown
F and my ruler is blue.

4 T I'm Mark. My pencil is
F green and my ruler is red.
My book is blue and my
pencil case is yellow.

5 T I'm Paul. My book is red
F and my ruler is blue.

2 Look and write.

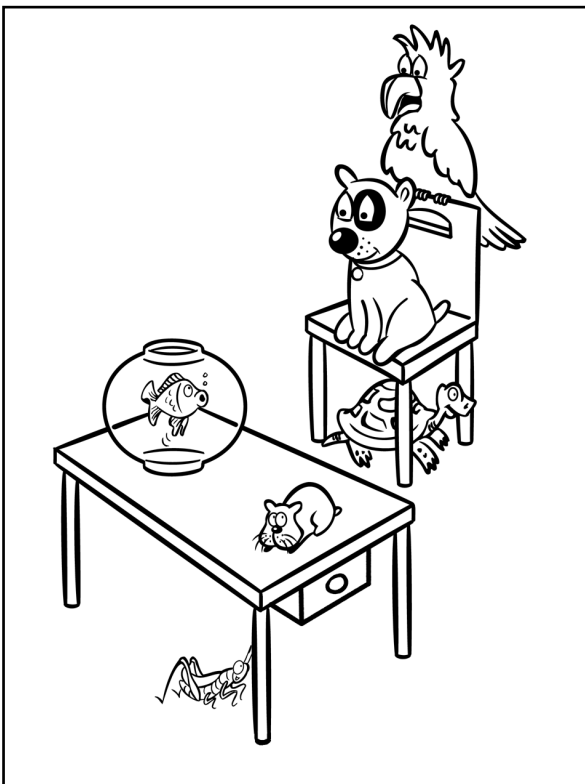

1 Where's the hamster?

It's on the desk.

2 Where's the bird?

3 Where's the tortoise?

4 Where's the fish?

5 Where's the grasshopper?

6 Where's the dog?

Bugs World 3

Name: _____

Unit 1 MIXED-ABILITY WORKSHEET 7

Class: _____

1 Colour the animal words. Write.

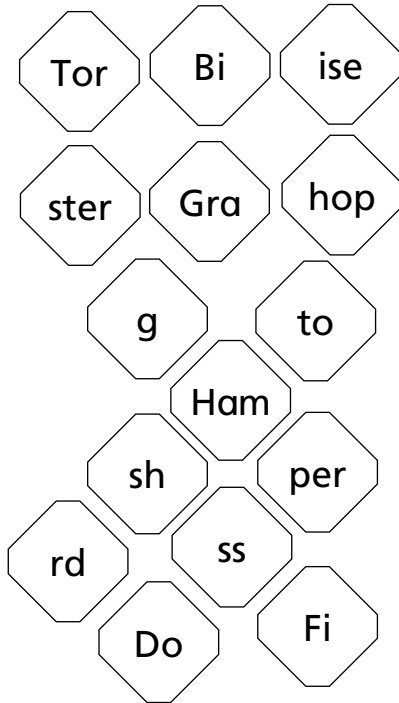

1 Tortoise _____



2 _____



3 _____



4 _____



5 _____



6 _____

2 Read, look and number.

1

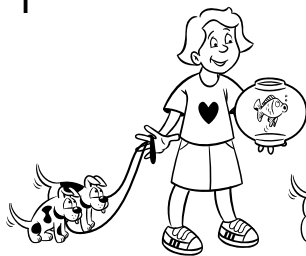

2

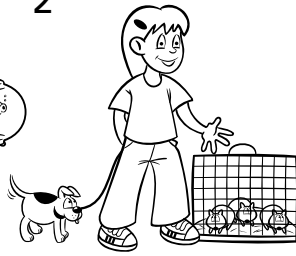

3



4



This is my pet dog
and three hamsters.

a

This is my pet fish
and two dogs.

b

This is my pet fish
and two hamsters.

c

This is my pet dog
and two birds.

d

Bugs World 3

Unit 1 MIXED-ABILITY WORKSHEET 8

Name: _____

Class: _____

1 Read, draw and colour.

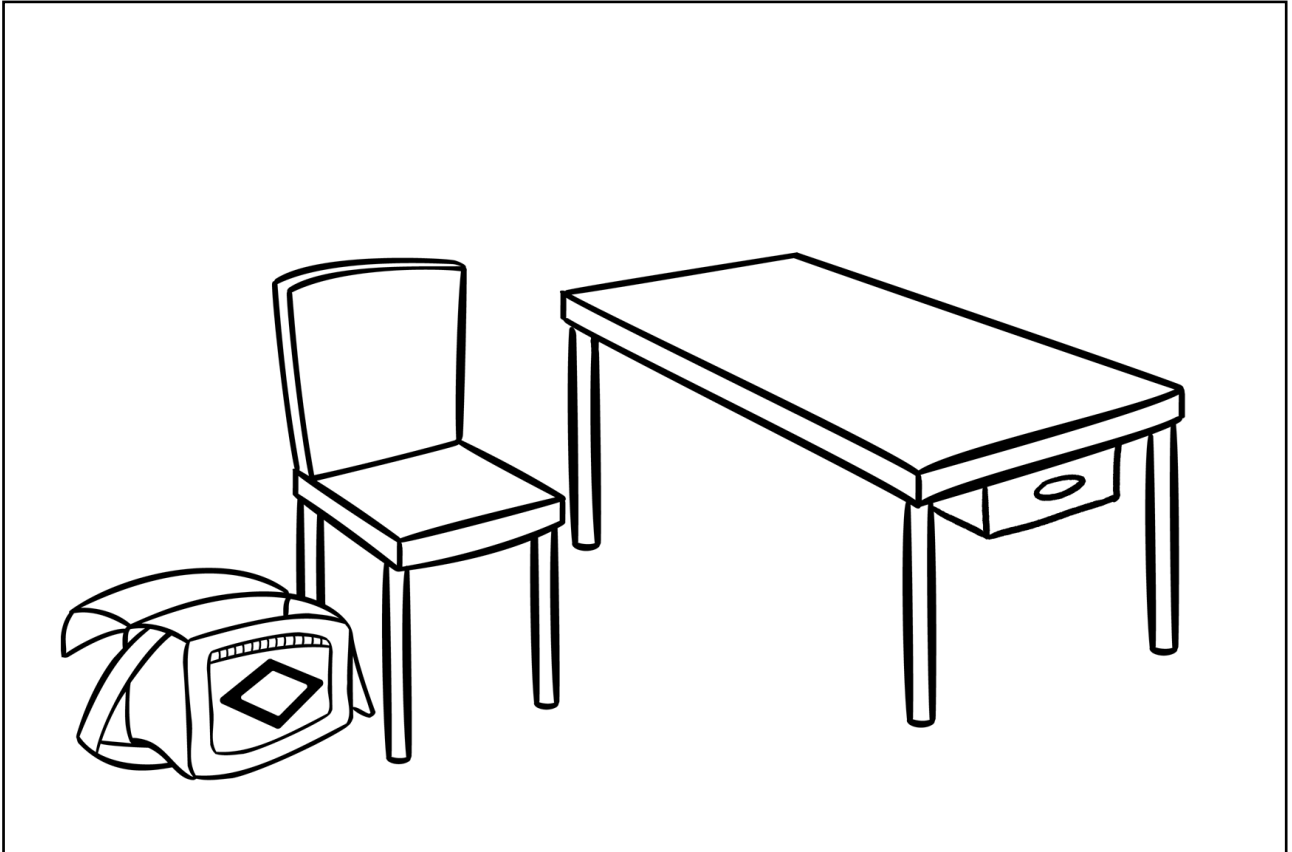

A brown and white dog is on the desk.
A red and yellow bird is under the chair.
A green and black tortoise is on the chair.
A brown hamster is in the school bag.

2 Read and write.

one two three four five six seven eight nine ten

1 one + one = two

2 six - four = _____

3 three + five = _____

4 four - three = _____

5 six + two = _____

6 five - two = _____

7 two + five = _____

8 eight - four = _____

9 one + eight = _____