

1 Look and write.

bathroom bedroom dining room garage  
garden hall kitchen living room

1 garden

2

3

4

5

6

7

8

2 Follow and write.

- 1 She's in the bedroom .      5 He's in the \_\_\_\_\_ .  
 2 He's in the \_\_\_\_\_ .      6 He's in the \_\_\_\_\_ .  
 3 She's in the \_\_\_\_\_ .      7 She's in the \_\_\_\_\_ .  
 4 She's in the \_\_\_\_\_ .      8 He's in the \_\_\_\_\_ .

## 1 Look and write.

bed bath cupboard sofa table

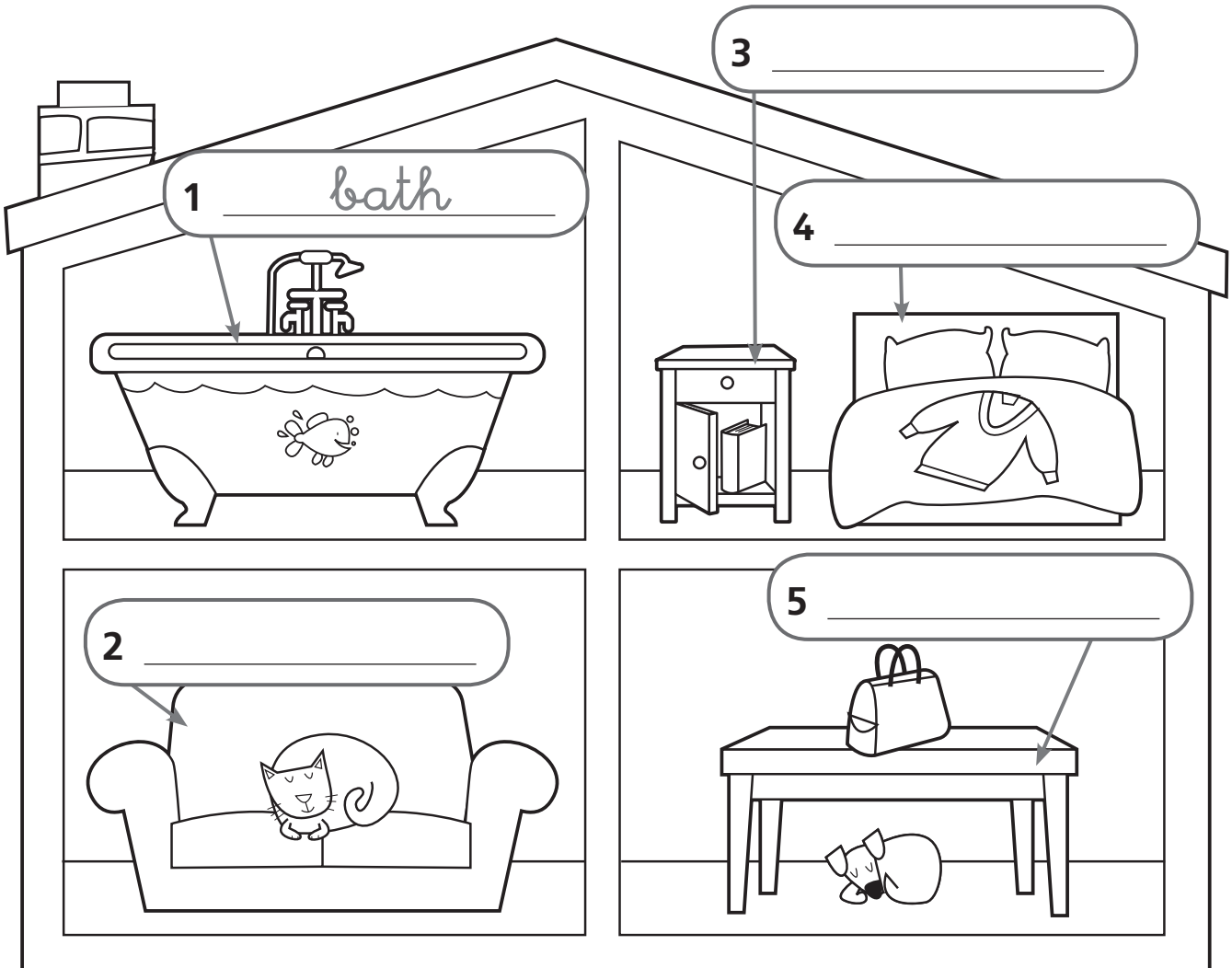

## 2 Look, circle and write.

- 1 The cat is in / on / under the sofa.
- 2 The dog is in / on / under the \_\_\_\_\_.
- 3 The fish is in / on / under the \_\_\_\_\_.
- 4 The book is in / on / under the \_\_\_\_\_.
- 5 The jumper is in / on / under the \_\_\_\_\_.
- 6 The bag is in / on / under the \_\_\_\_\_.

1 Look and circle.

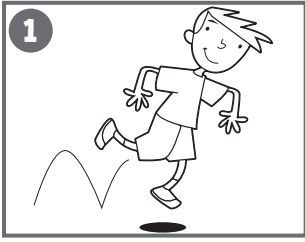

catch / hop



read / write

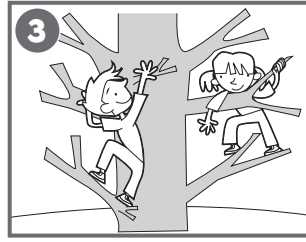

climb / write

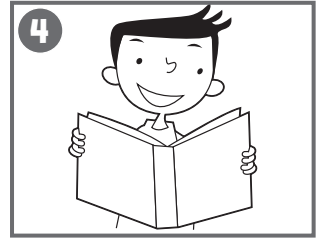

read / draw

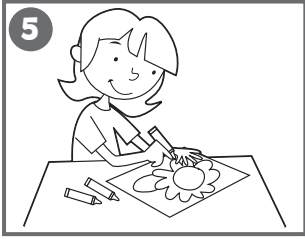

draw /  
play football



hop /  
play football

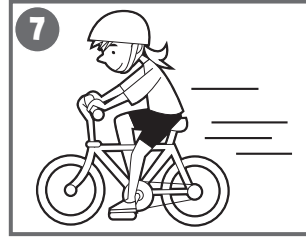

ride a bike /  
draw

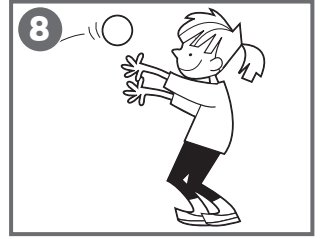

ride a bike /  
catch

2 Look and write.

catch climb draw hop play football  
~~read~~ ride a bike write



1 She can read.

5 She can \_\_\_\_\_.

2 He can't \_\_\_\_\_.

6 He can't \_\_\_\_\_.

3 She can't \_\_\_\_\_.

7 She can't \_\_\_\_\_.

4 He can \_\_\_\_\_.

8 She can \_\_\_\_\_.

**1** Circle and write.

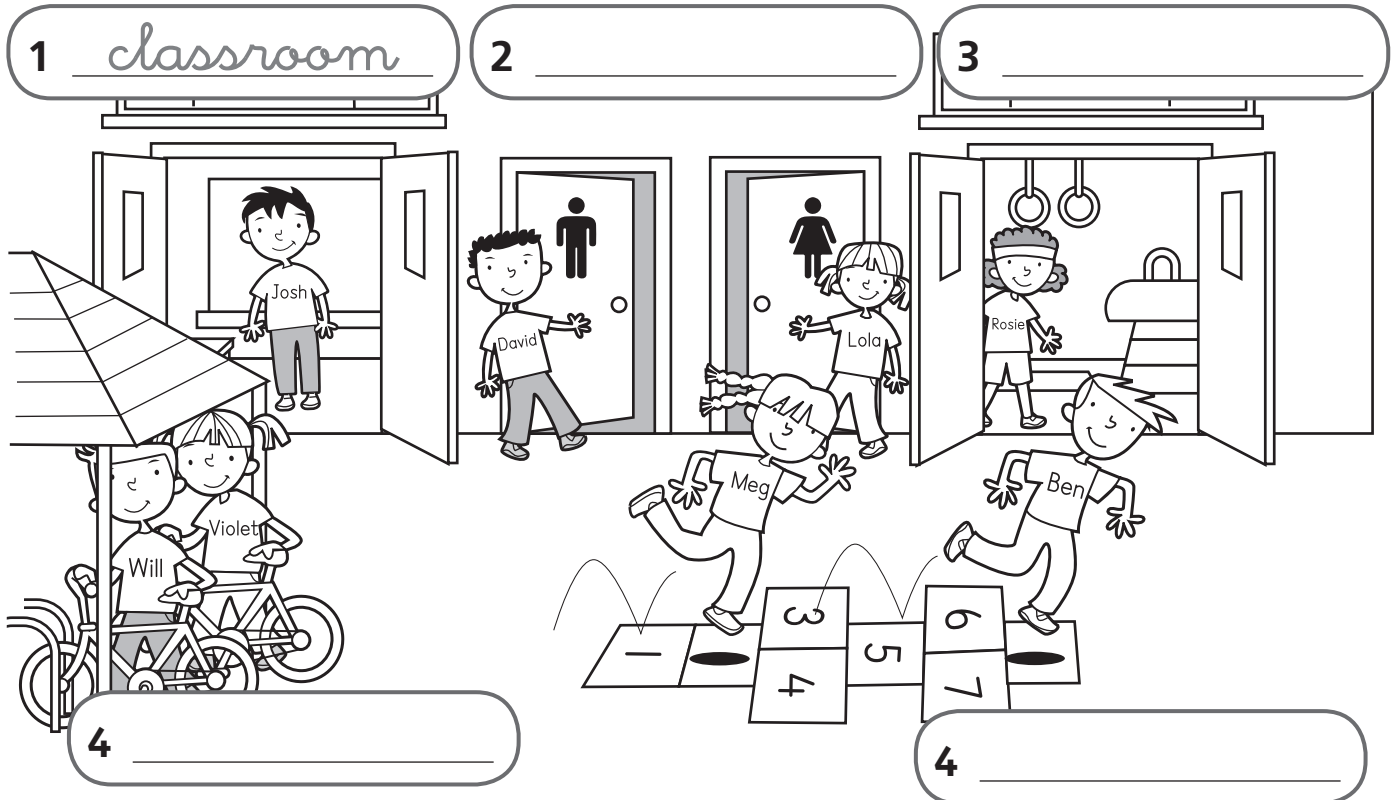
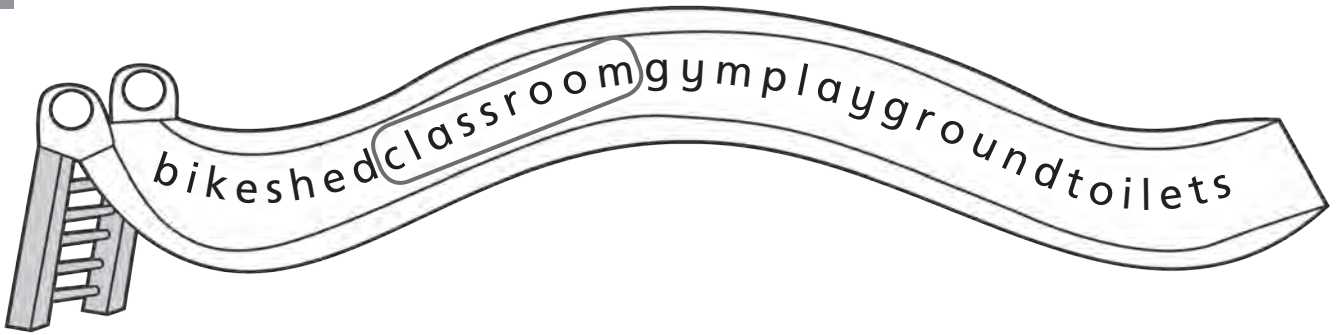

**2** Look and write *He's* or *She's*.

1 \_\_\_\_\_ in the toilet.

David

2 \_\_\_\_\_ in the toilet.

Lola

3 \_\_\_\_\_ in the bike shed.

Will

4 \_\_\_\_\_ in the classroom.

Josh

5 \_\_\_\_\_ in the gym.

Rosie

6 \_\_\_\_\_ in the playground.

Ben

7 \_\_\_\_\_ in the bike shed.

Violet

8 \_\_\_\_\_ in the playground.

Meg

**1 Look and write.**

farm hill lake ~~rainbow~~ road rock river tree



- 1 rainbow
- 2 \_\_\_\_\_
- 3 \_\_\_\_\_
- 4 \_\_\_\_\_
- 5 \_\_\_\_\_
- 6 \_\_\_\_\_
- 7 \_\_\_\_\_
- 8 \_\_\_\_\_

**2 Read and circle.**

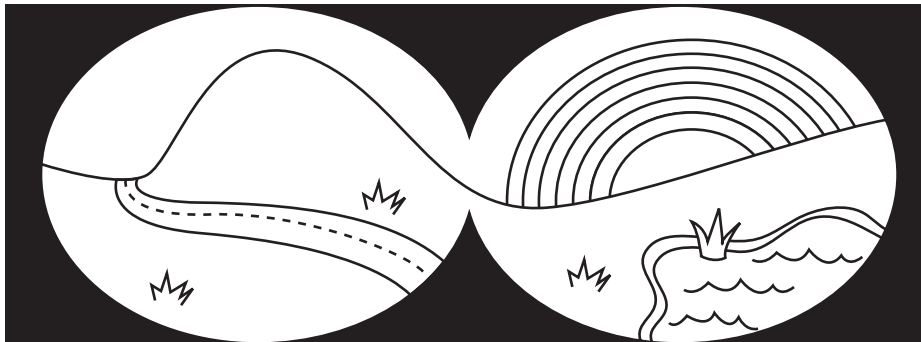

1 Can you see a lake?

Yes, I can. / No, I can't.

2 Can you see a tree?

Yes, I can. / No, I can't.

3 Can you see a rainbow?

Yes, I can. / No, I can't.

4 Can you see a hill?

Yes, I can. / No, I can't.

5 Can you see a river?

Yes, I can. / No, I can't.

6 Can you see a road?

Yes, I can. / No, I can't.

7 Can you see a rock?

Yes, I can. / No, I can't.

8 Can you see a farm?

Yes, I can. / No, I can't.

1 Write.

deer fox hedgehog owl spider

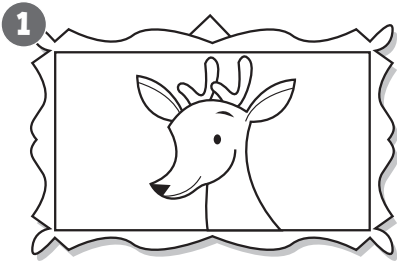

deer

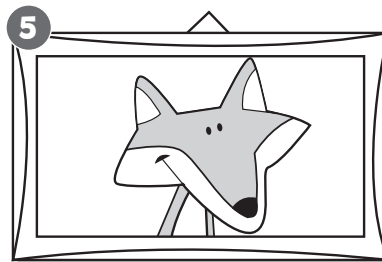
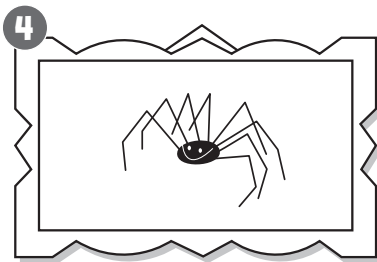
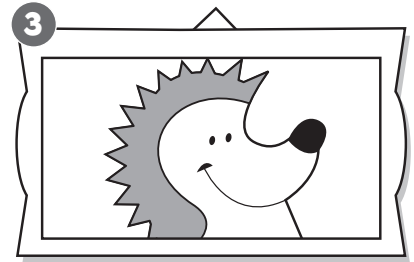
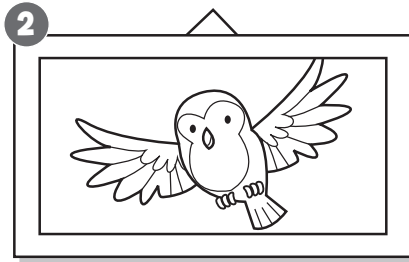

2 Look and write.

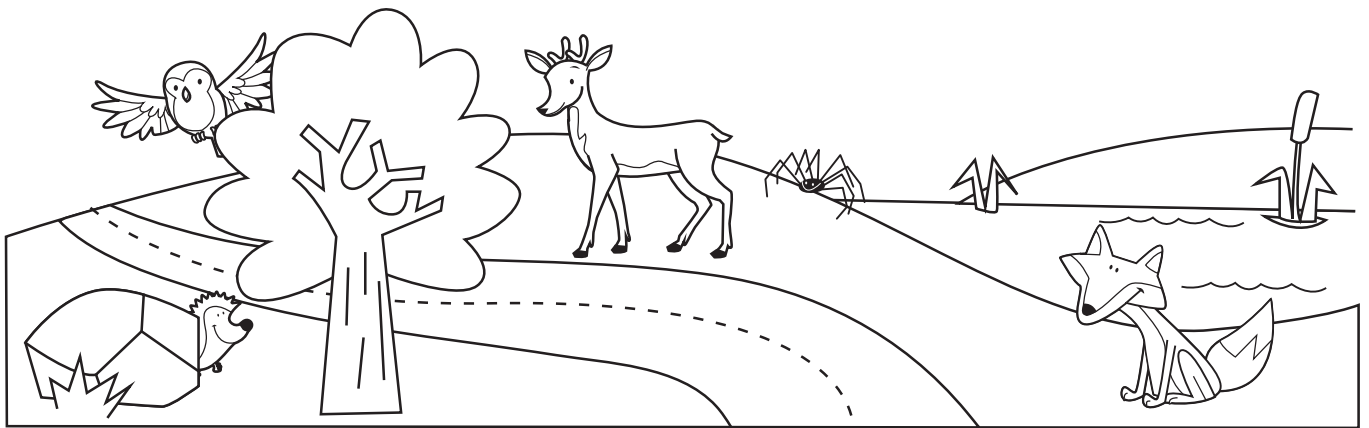

1 The fox is in front of the lake.

2 The \_\_\_\_\_ is behind the tree.

3 The \_\_\_\_\_ is next to the lake.

4 The \_\_\_\_\_ is behind the rock.

5 The \_\_\_\_\_ is next to the road.

**1 Write.**

dark eyes freckles glasses hair long

1 blond hair

2 \_\_\_\_\_ hair

3 blue  
\_\_\_\_\_

4 \_\_\_\_\_

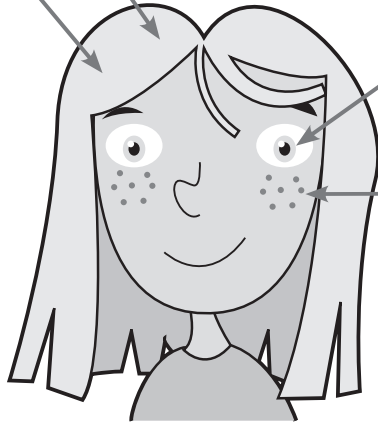

5 short \_\_\_\_\_

7 brown  
\_\_\_\_\_

6 \_\_\_\_\_ hair

8 \_\_\_\_\_

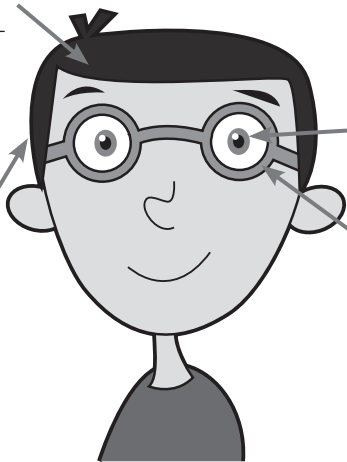

**2 Look and write.**

She's got blue eyes.  
 She's got long \_\_\_\_\_.  
 She's got \_\_\_\_\_ hair.  
 \_\_\_\_\_.

He's got \_\_\_\_\_ eyes.  
 He's got \_\_\_\_\_ hair.  
 He's got dark \_\_\_\_\_.  
 \_\_\_\_\_.

1 Circle and write.

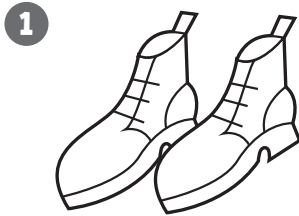
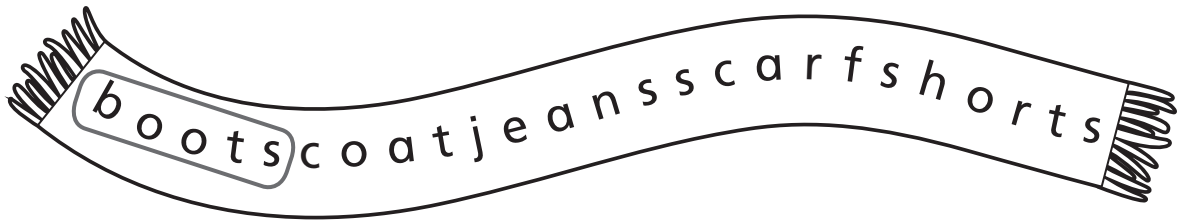

boots

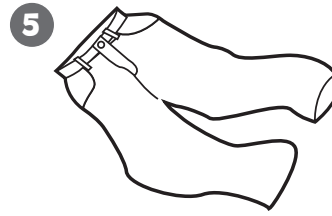
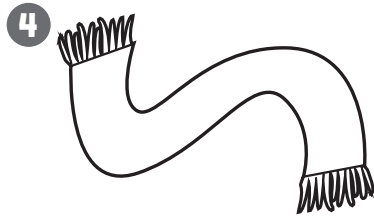
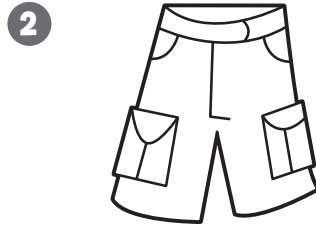

2 Look, read and write the names.

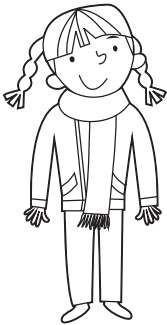

Emma



Alice

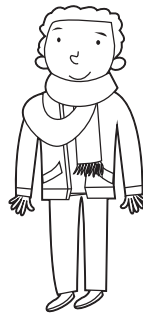

Tom



Beth



Jack

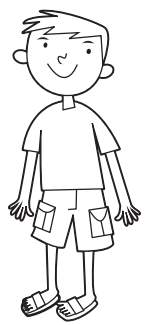

Finn

1 He's wearing jeans. Jack

2 She's wearing shorts. \_\_\_\_\_

3 He's wearing shorts. \_\_\_\_\_

4 She's wearing jeans and boots. \_\_\_\_\_

5 He's wearing a coat and a scarf. \_\_\_\_\_

6 She's wearing a coat and a scarf. \_\_\_\_\_



## 1 Circle and write.

bees chicken cow donkey duck goat pig sheep

1

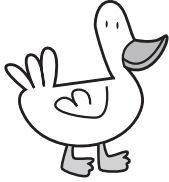

2

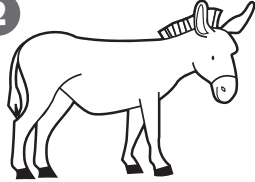

3

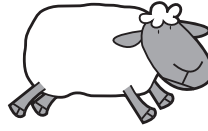

4

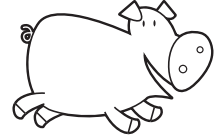

5

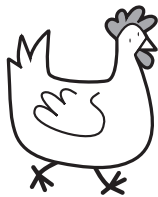

6

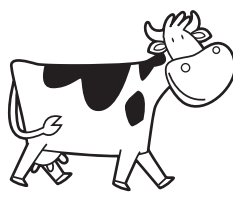

7

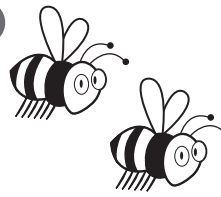

8

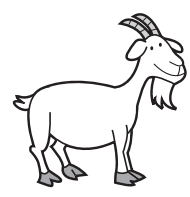

## 2 Look and circle.

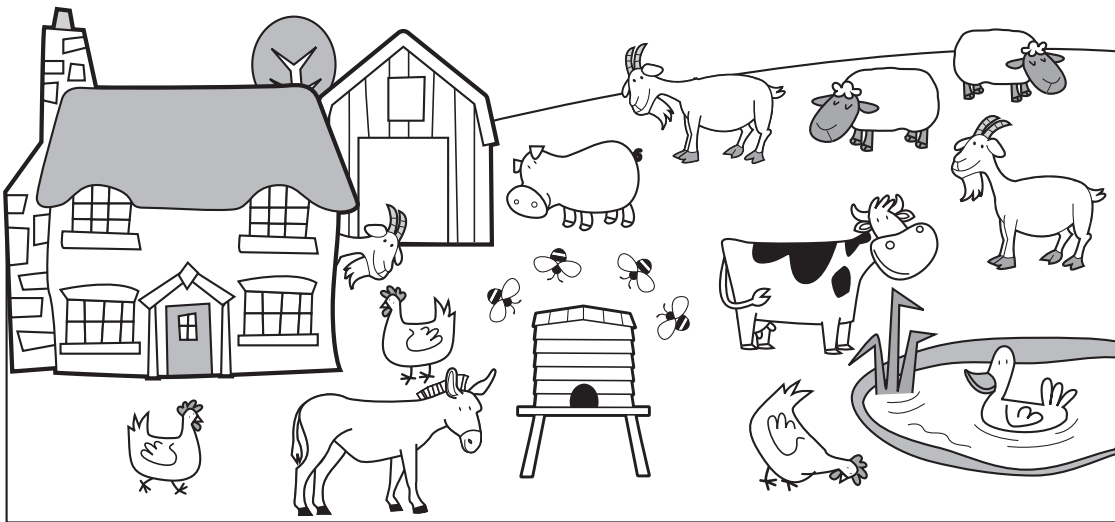

1 There is / are a bee / bees.

5 There is / are a cow / cows.

2 There is / are a pig / pigs.

6 There is / are a sheep / sheep.

3 There is / are a duck / ducks.

7 There is / are a donkey /

4 There is / are a chicken /  
chickens.

donkeys.

8 There is / are a goat / goats.

1 Follow and write.

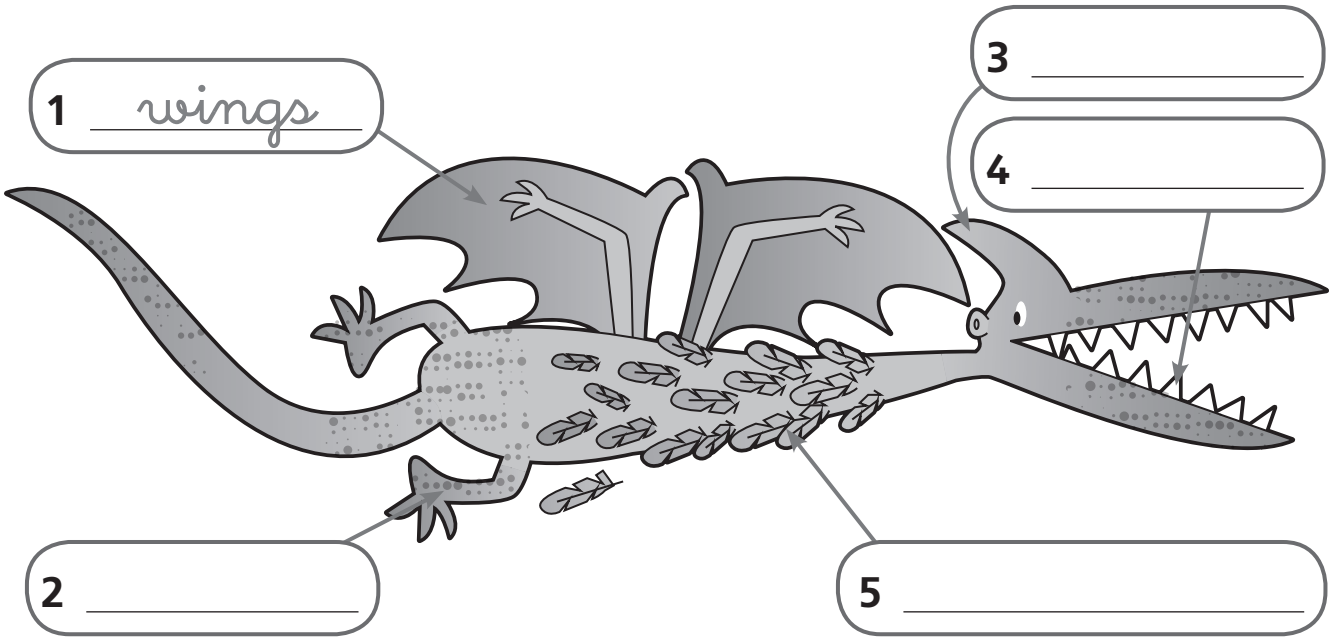

ears feathers feet teeth ~~wings~~



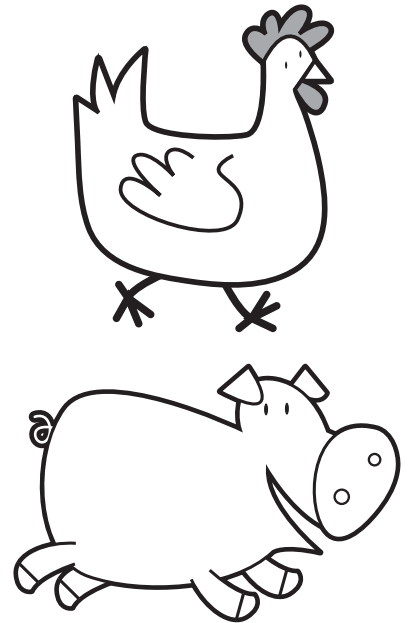

2 Look and write. Read and match.

1 It's got  wings .  
 It hasn't got  \_\_\_\_\_ .

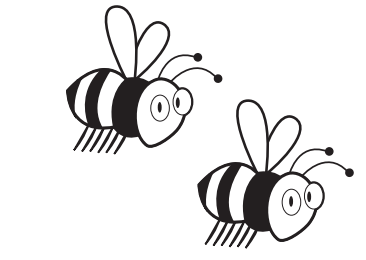

2 It's got  \_\_\_\_\_ .  
 It hasn't got  \_\_\_\_\_ .



3 It's got  \_\_\_\_\_ .  
 It hasn't got  \_\_\_\_\_ .

1 Write.

juice lemonade milk pasta pizza popcorn salad ~~soup~~

1   soup  

2 \_\_\_\_\_

3 \_\_\_\_\_

4 \_\_\_\_\_

5 \_\_\_\_\_

6 \_\_\_\_\_

7 \_\_\_\_\_

8 \_\_\_\_\_

2 Look and write.

I'm eating  
  pizza   and  
\_\_\_\_\_.

I'm drinking  
\_\_\_\_\_.

I'm eating  
\_\_\_\_\_.

I'm drinking  
\_\_\_\_\_.

I'm eating  
\_\_\_\_\_ and  
\_\_\_\_\_.





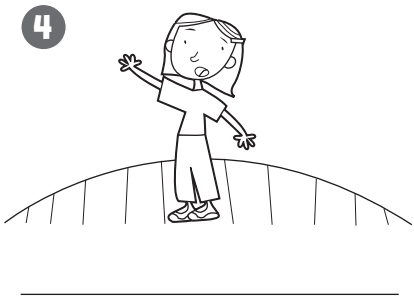
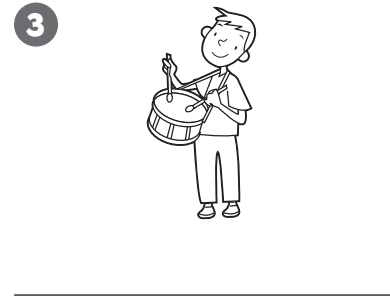
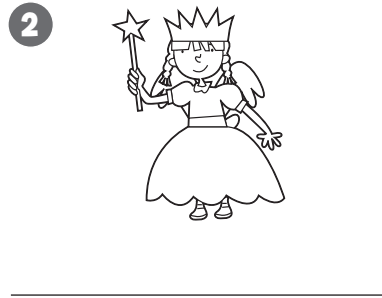
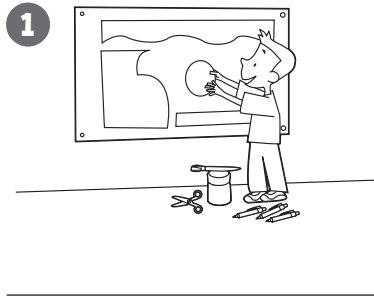

I'm drinking  
\_\_\_\_\_.

**1** Circle and write.

acting dressing up making posters painting playing music

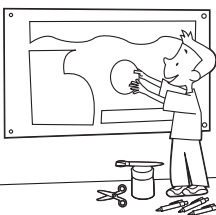

**2** Look and write.

	
<p>1 </p> <p>2 </p> <p>3 </p>	<p>4 </p> <p>5 </p>

1 I like dressing up.

4 I don't like \_\_\_\_\_.

2 I like \_\_\_\_\_.

5 I don't like \_\_\_\_\_.

3 I like \_\_\_\_\_.

**1 Look and write.**

a a a a a      e e e e      i i i i i      o o o o o o o o

1 b a thr o o m      2 h \_ \_ ll      3 b \_ \_ dr \_ \_ \_ m

4 g \_ \_ rd \_ \_ n

5 g \_ \_ r \_ \_ g \_ \_

6 k \_ \_ tch \_ \_ n      7 l \_ \_ v \_ \_ ng r \_ \_ \_ m

8 d \_ \_ n \_ \_ ng r \_ \_ \_ m

**2 Look and write.**

1 Where is he? He's in the garden.  
Where is she? She's in the \_\_\_\_\_.

2 Where is she? \_\_\_\_\_ in the \_\_\_\_\_.  
Where is he? \_\_\_\_\_ in the \_\_\_\_\_.

3 Where is he? \_\_\_\_\_.  
Where is she? \_\_\_\_\_.

4 Where is she? \_\_\_\_\_.  
Where is he? \_\_\_\_\_.

1 Write.

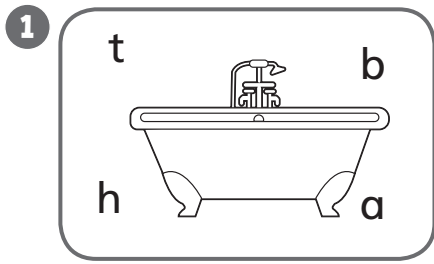

bath

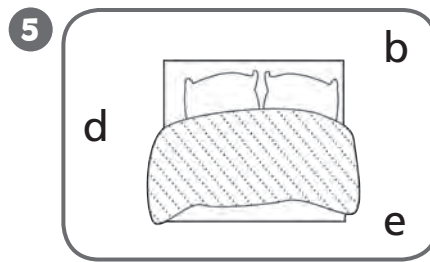
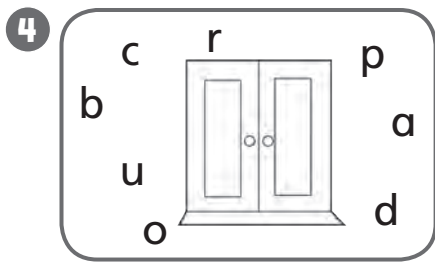
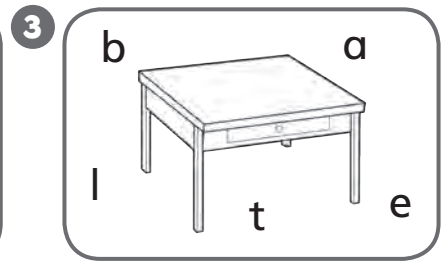
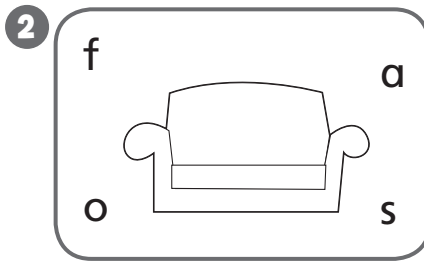

2 Look and write.

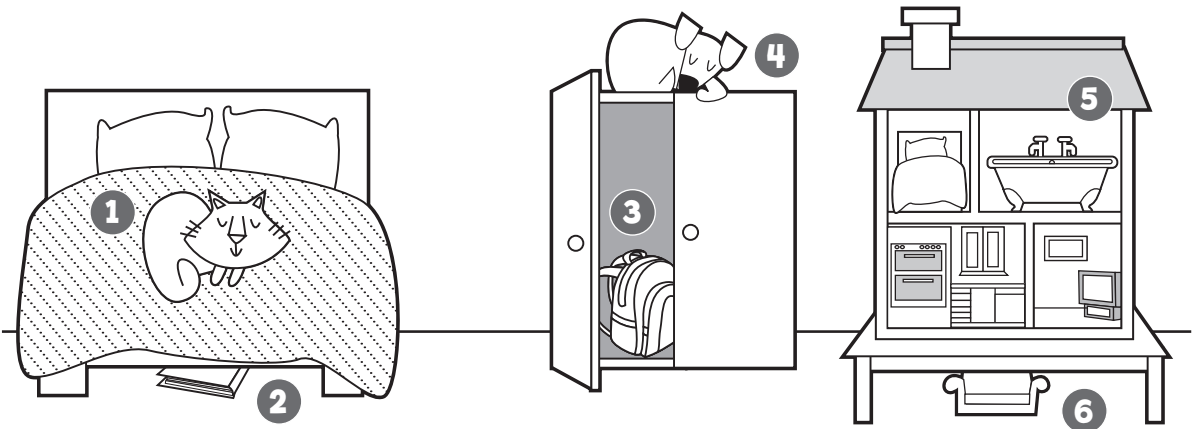

1 The cat is on the bed.

2 The book is under the \_\_\_\_\_.

3 The bag is in the \_\_\_\_\_.

4 The dog \_\_\_\_\_ the \_\_\_\_\_.

5 The \_\_\_\_\_ is \_\_\_\_\_ the \_\_\_\_\_.

6 \_\_\_\_\_

**1 Write and match.**

a a a ay e e ea i i i o oo

1 pl \_\_\_ f \_\_\_ tb \_\_\_ ll

2 r \_\_\_ de a bik \_\_\_

3 cl i mb

4 r \_\_\_ d

5 wr \_\_\_ t \_\_\_

6 dr \_\_\_ w

7 c \_\_\_ tch

8 h \_\_\_ p

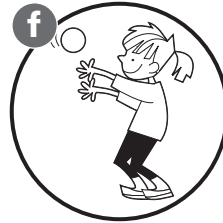
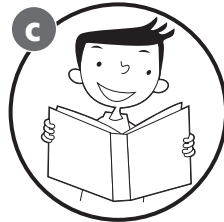
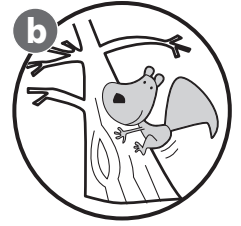

**2 Look, circle and write.**



He can / can't climb .

He can / can't \_\_\_\_\_ .

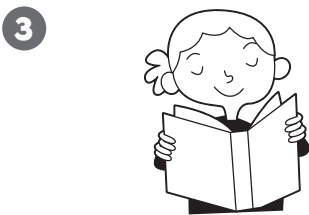

She can / can't \_\_\_\_\_ .

He \_\_\_\_\_ .

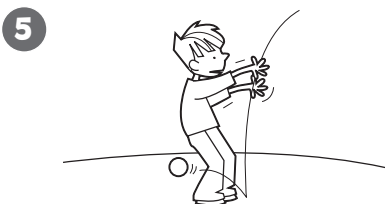

He \_\_\_\_\_ .

She \_\_\_\_\_ .

**1 Write. Find and circle.**

a a e e e i i o o o o t u y y

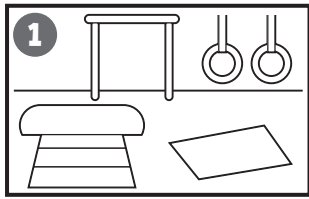

g \_ \_ m



t \_ \_ \_ l \_ \_ \_ s

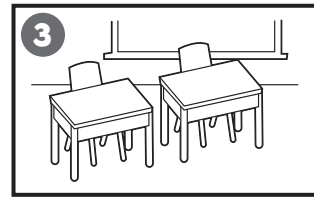

cl \_ \_ ssr \_ \_ \_ m

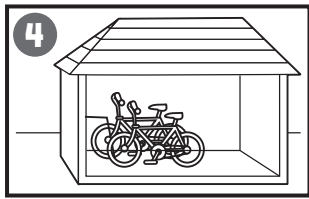

b \_ \_ k \_ \_ sh \_ \_ d

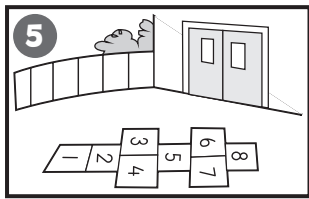

pl \_ \_ \_ gr \_ \_ \_ nd

p	c	g	r	c	e	g	e	t	q
e	e	y	y	n	r	e	t	d	s
d	b	m	f	v	e	a	b	o	s
v	r	s	q	o	s	l	p	l	m
t	o	i	l	e	t	s	l	a	a
p	l	a	y	g	r	o	u	n	d
x	e	j	e	o	c	z	g	n	e
c	l	a	s	s	r	o	o	m	i
a	b	b	i	k	e	s	h	e	d

**2 Look and write.**

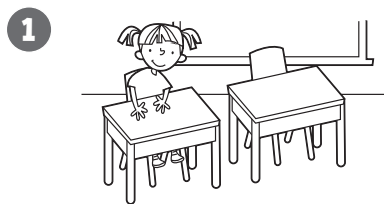

She is in the classroom.



He isn't in the bike shed.



She \_\_\_\_\_ in the toilets.

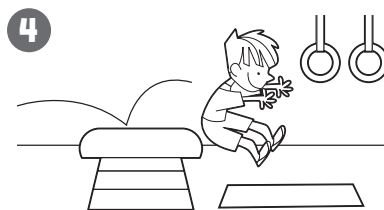

He \_\_\_\_\_ in the gym.

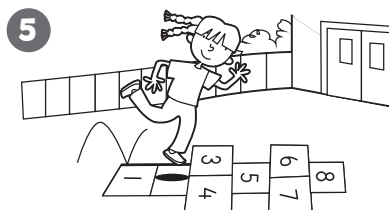

\_\_\_\_\_ in the playground.

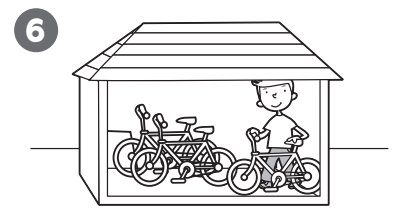

\_\_\_\_\_ in the gym.



**1** Look and write the differences.

farm hill lake rainbow river road rock tree

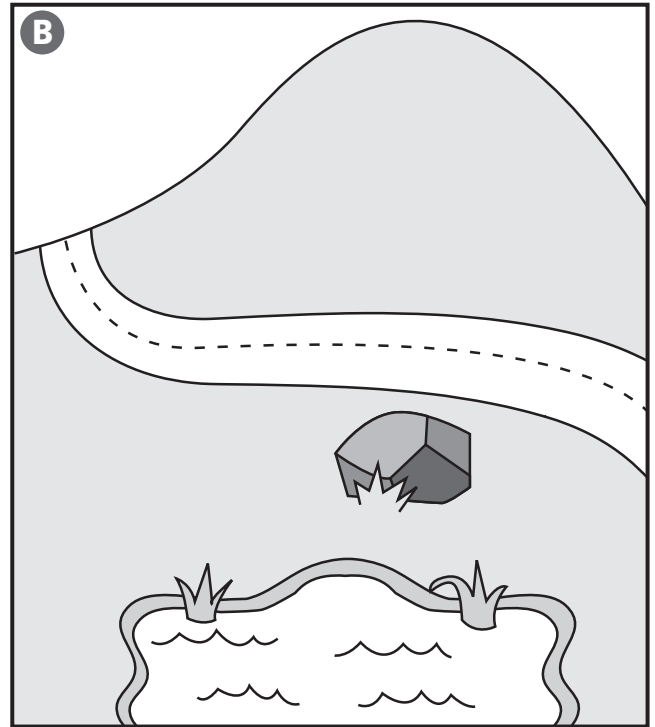
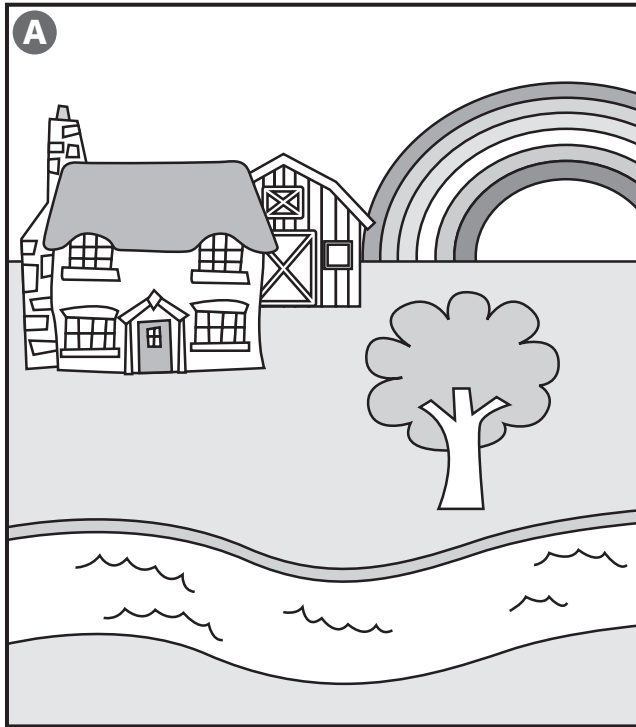

- 1 \_\_\_\_\_
- 2 \_\_\_\_\_
- 3 \_\_\_\_\_
- 4 \_\_\_\_\_

- 5 \_\_\_\_\_
- 6 \_\_\_\_\_
- 7 \_\_\_\_\_
- 8 \_\_\_\_\_

**2** Look at picture A and answer *Yes, I can* or *No, I can't*.

1 Can you see a river?

Yes, I can.

2 Can you see a rock?

No, I \_\_\_\_\_.

3 Can you see a tree?

\_\_\_\_\_

4 Can you see a farm?

\_\_\_\_\_

5 Can you see a road?

\_\_\_\_\_

6 Can you see a lake?

\_\_\_\_\_

7 Can you see a rainbow?

\_\_\_\_\_

8 Can you see a hill?

\_\_\_\_\_

1 Look and write.

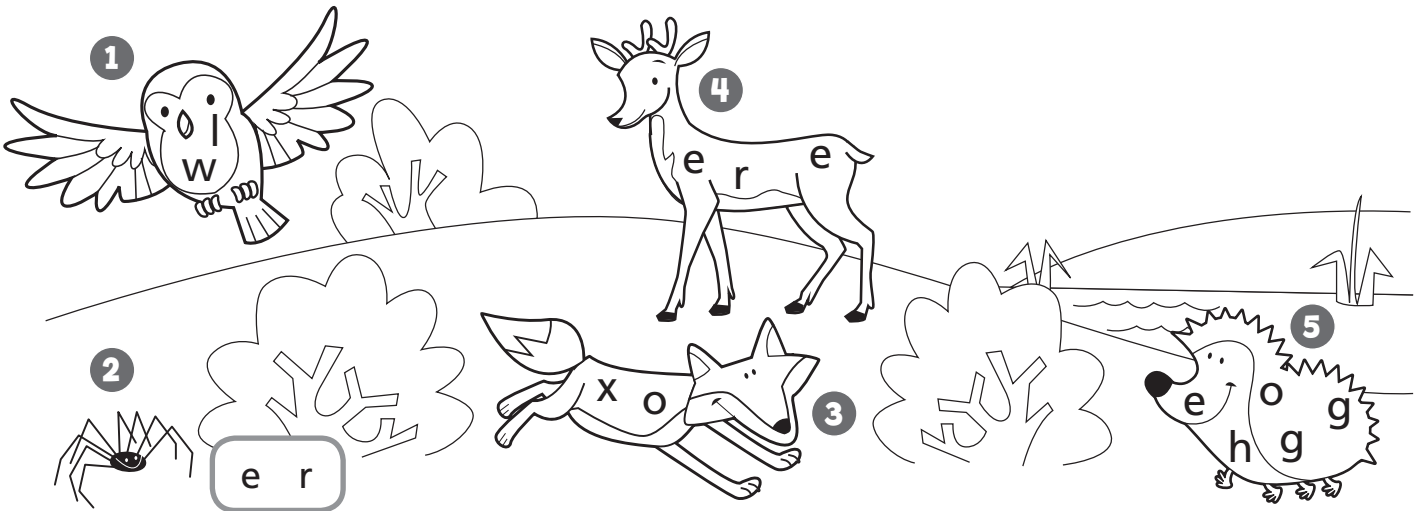

1 o w l

2 spid \_\_\_\_

3 f \_\_\_\_

4 d \_\_\_\_

5 hed \_\_\_\_

2 Look and write.

next to behind in front of

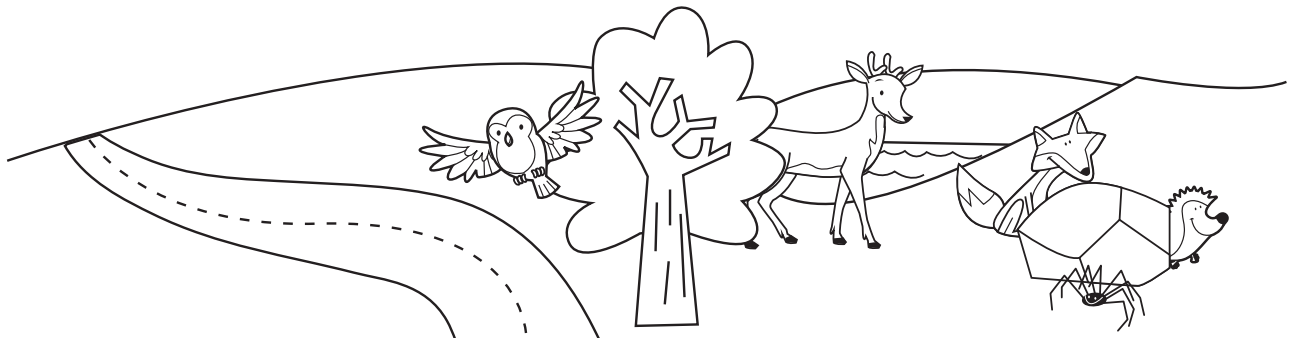

1 The fox is next to the deer.

2 The hedgehog is \_\_\_\_\_ the rock.

3 The deer is \_\_\_\_\_ the tree.

4 The owl is \_\_\_\_\_ the tree.

5 The spider is \_\_\_\_\_ the rock.

6 The fox is \_\_\_\_\_ the rock.

7 The owl is \_\_\_\_\_ the road.

8 The deer is \_\_\_\_\_ the lake.

**1 Write. Find and circle.**

a a e e e e e e e o o o o



bl \_\_\_ nd hair



fr \_\_\_ ckl \_\_\_ s



l \_\_\_ ng hair



sh \_\_\_ rt hair

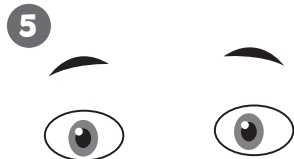

\_\_\_ y \_\_\_ br \_\_\_ ws



blue \_\_\_ y \_\_\_ s

w	n	w	a	e	y	e	s	e
s	l	e	h	e	g	y	c	d
f	r	e	c	k	l	e	s	c
l	o	n	g	x	a	b	h	v
q	s	u	e	d	s	r	o	s
m	g	u	n	a	s	o	r	p
u	l	o	t	r	e	w	t	n
y	l	w	e	k	s	s	m	e
b	m	s	s	u	t	g	j	t



gl \_\_\_ ss \_\_\_ s



d \_\_\_ rk hair

**2 Write. Read, draw and colour.**

- 1 She's got gl \_\_\_\_\_.
- 2 She's got long \_\_\_\_\_.
- 3 She's got d \_\_\_\_\_ hair.
- 4 She's got blue \_\_\_\_\_.
- 5 He's got fr \_\_\_\_\_.
- 6 He's got blond \_\_\_\_\_.
- 7 He's got s \_\_\_\_\_ hair.
- 8 He's got brown \_\_\_\_\_.

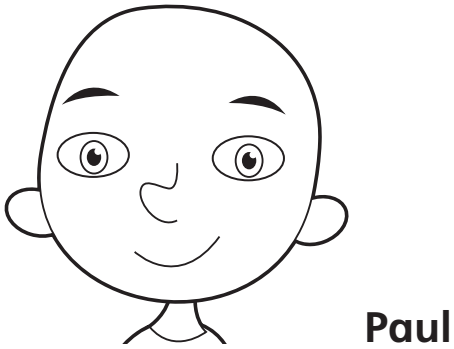
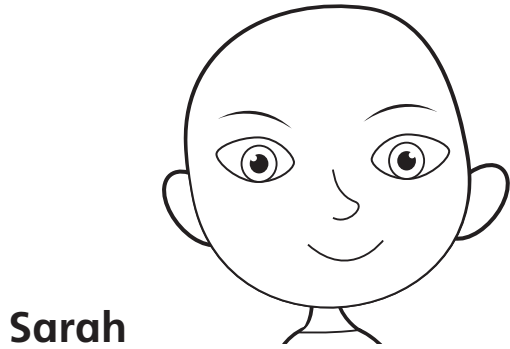

**1 Write and match.**

1 o a  
c t \_\_\_\_\_

*coat*



2 s a c  
r f \_\_\_\_\_



3 o b t  
o s \_\_\_\_\_



4 h o s  
s t r \_\_\_\_\_



5 e a s  
j n \_\_\_\_\_



**2 Write.**

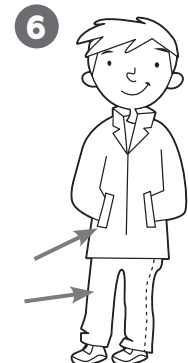
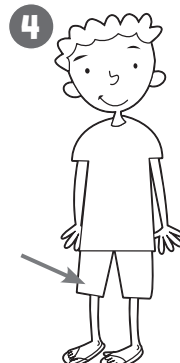
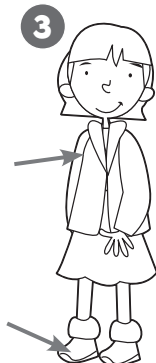
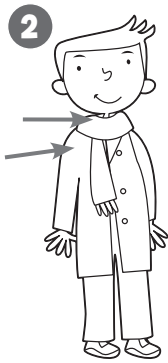
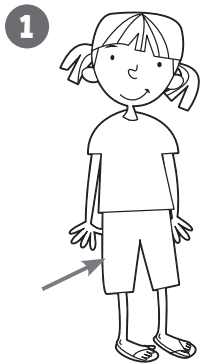

1 She's wearing shorts.

2 He's wearing a \_\_\_\_\_ and a \_\_\_\_\_.

3 She's wearing a \_\_\_\_\_ and \_\_\_\_\_.

4 \_\_\_\_\_.

5 \_\_\_\_\_.

6 \_\_\_\_\_ and \_\_\_\_\_.

**1 Look and write. Count.**

bees chickens cow donkey ducks goat pigs sheep

a bees

b

c

d

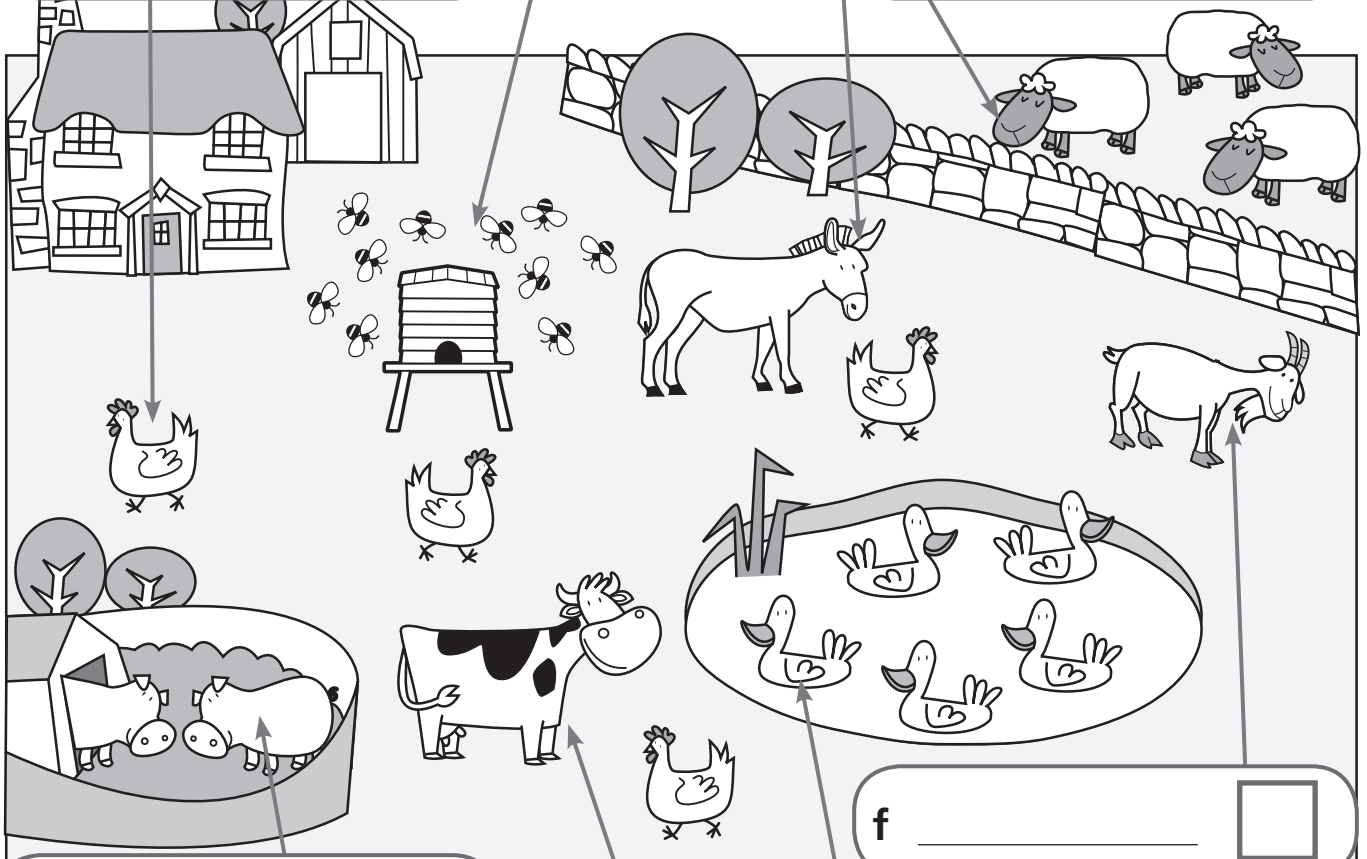

e

f

g

h

**2 Look and write.**

a There are 10 bees. e \_\_\_\_\_.

b There is 1 donkey. f \_\_\_\_\_.

c There \_\_\_\_\_. g \_\_\_\_\_.

d There \_\_\_\_\_. h \_\_\_\_\_.

**1 Look and write. Match.**

et gs rs rs th



1 win g s

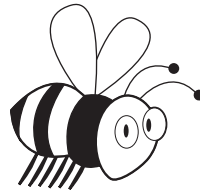
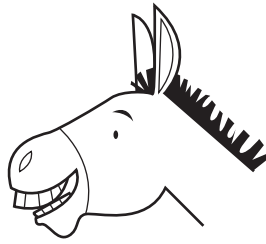

4 feathe      



2 fe      

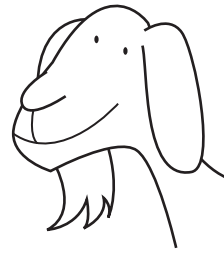
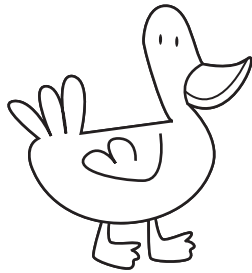

5 tee      

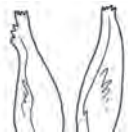

3 ea      

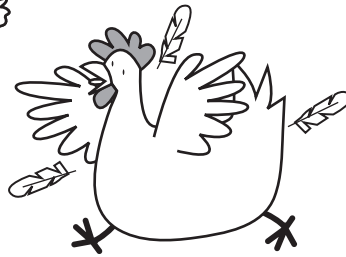

**2 Look and write.**

1

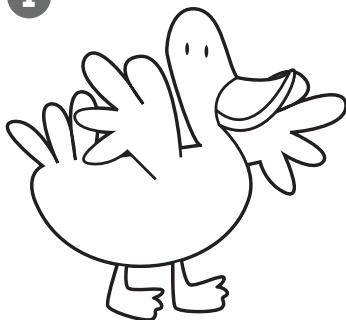

It's got 2 wings.

It's got 2 \_\_\_\_\_.



It hasn't got \_\_\_\_\_.



It hasn't got \_\_\_\_\_.

2

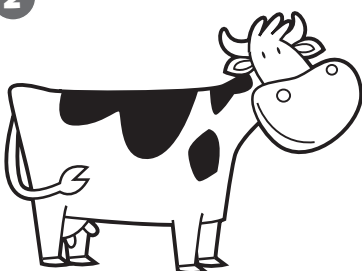

\_\_\_\_\_ 4 \_\_\_\_\_.

\_\_\_\_\_ 2 \_\_\_\_\_.



It hasn't got \_\_\_\_\_.



It hasn't got \_\_\_\_\_.

**1** Look and write. Complete the table.

1 s l a d a



2 n p o c p o



3 u c i j e



4 z i z a p



5 a m e l e o n d



6 l k i m



7 a p s t a



8 o s u p



Drink	Food
<u>milk</u>	<u>salad</u>
_____	_____
_____	_____

**2** Write.

1 I'm drinking milk  
and \_\_\_\_\_.  
I'm eating  
\_\_\_\_\_.

2 I'm \_\_\_\_\_.  
I'm \_\_\_\_\_  
\_\_\_\_\_ and  
\_\_\_\_\_.

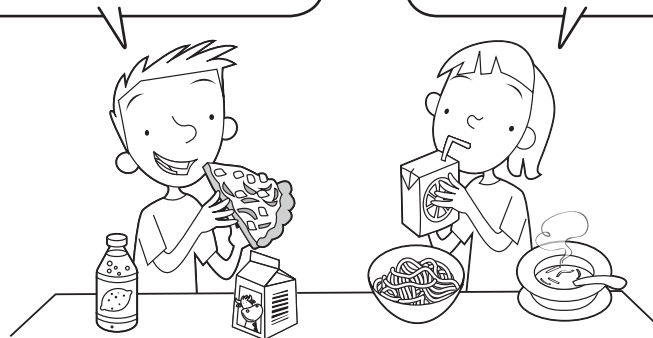

**1 Match and write.**

1 dre in ing



\_\_\_\_\_

2 ac ssing ting

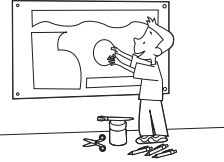

\_\_\_\_\_

3 pa t up \_\_\_\_\_



*dressing up*

4 ma ying posters



\_\_\_\_\_

5 pla king music



\_\_\_\_\_

**2 Look and write.**

1 *I like acting.*

2 *I don't like dressing up.*

4 \_\_\_\_\_  
\_\_\_\_\_

3 \_\_\_\_\_  
\_\_\_\_\_

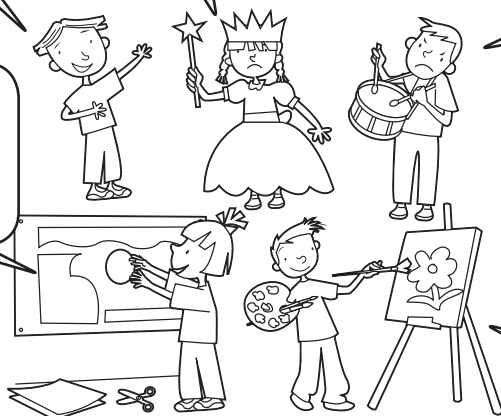

5 \_\_\_\_\_  
\_\_\_\_\_

**3 Write 2 sentences for you.**

I like \_\_\_\_\_.

I don't like \_\_\_\_\_.



# Teaching Notes

## Unit 1 Reinforcement 1

### 1 Look and write.

- 1 garden
- 2 dining room
- 3 bedroom
- 4 kitchen
- 5 living room
- 6 garage
- 7 bathroom
- 8 hall

### 2 Follow and write.

- 1 bedroom
- 2 garden
- 3 bathroom
- 4 living room
- 5 hall
- 6 garage
- 7 kitchen
- 8 dining room

## Unit 1 Reinforcement 2

### 1 Look and write.

- 1 bath
- 2 sofa
- 3 cupboard
- 4 bed
- 5 table

### 2 Look, circle and write.

- 1 The cat is *on* the *sofa*.
- 2 The dog is *under* the *table*.
- 3 The fish is *in* the *bath*.
- 4 The book is *in* the *cupboard*.
- 5 The jumper is *on* the *bed*.
- 6 The bag is *on* the *table*.

## Unit 2 Reinforcement 1

### 1 Look and circle.

- 1 hop
- 2 write
- 3 climb
- 4 read
- 5 draw
- 6 play football
- 7 ride a bike
- 8 catch

### 2 Look and write.

- 1 read
- 2 ride a bike
- 3 climb
- 4 write
- 5 draw
- 6 catch
- 7 hop
- 8 play football

## Unit 2 Reinforcement 2

### 1 Circle and write.

- 1 classroom
- 2 toilet
- 3 gym
- 4 bike shed
- 5 playground

### 2 Look and write *He's* or *She's*.

- 1 He's
- 2 She's
- 3 He's
- 4 He's
- 5 She's
- 6 He's
- 7 She's
- 8 She's

## Unit 3 Reinforcement 1

### 1 Look and write.

- 1 rainbow
- 2 lake
- 3 river
- 4 road
- 5 tree
- 6 hill
- 7 rock
- 8 farm

### 2 Read and circle.

- 1 Yes, I can.
- 2 No, I can't.
- 3 Yes, I can.
- 4 Yes, I can.
- 5 No, I can't.
- 6 Yes, I can.
- 7 No, I can't.
- 8 No, I can't.

## Unit 3 Reinforcement 2

### 1 Write.

- 1 deer
- 2 owl
- 3 hedgehog
- 4 spider
- 5 fox

### 2 Look and write.

- 1 fox
- 2 owl
- 3 spider
- 4 hedgehog
- 5 deer

## Unit 4 Reinforcement 1

### 1 Write.

- 1 blond *hair*
- 2 long *hair*
- 3 blue *eyes*
- 4 *freckles*
- 5 short *hair*
- 6 dark *hair*
- 7 brown *eyes*
- 8 *glasses*

### 2 Look and write.

She's got *blue* eyes.  
 She's got long *hair*.  
 She's got *blond* hair.  
 She's got *freckles*.  
 He's got *brown* eyes.  
 He's got *short* hair.  
 He's got dark *hair*.  
 He's got *glasses*.

## Unit 4 Reinforcement 2

### 1 Circle and write.

- 1 boots
- 2 shorts
- 3 coat
- 4 scarf
- 5 jeans

### 2 Look, read and write the names.

- 1 Jack
- 2 Alice
- 3 Emily
- 4 Beth
- 5 Tom
- 6 Ruby

## Unit 5 Reinforcement 1

### 1 Circle and write.

- 1 duck
- 2 donkey
- 3 sheep
- 4 pig
- 5 chicken
- 6 cow
- 7 bees
- 8 goat

### 2 Look and circle.

- 1 There are bees.
- 2 There is a pig.
- 3 There is a duck.
- 4 There are chickens.
- 5 There is a cow.
- 6 There are sheep.
- 7 There is a donkey.
- 8 There are goats.

## Unit 5 Reinforcement 2

### 1 Follow and write.

- 1 wings
- 2 feet
- 3 ears
- 4 teeth
- 5 feathers

### 2 Look and write. Read and match.

- 1 It's got *wings*. It hasn't got *feathers*. – bee
- 2 It's got *feathers*. It hasn't got *ears*. – chicken
- 3 It's got *feet*. It hasn't got *wings*. – pig

## Unit 6 Reinforcement 1

### 1 Write.

- 1 soup
- 2 milk
- 3 pizza
- 4 popcorn
- 5 pasta
- 6 lemonade
- 7 salad
- 8 juice

### 2 Look and write.

- 1 I'm eating *pizza* and *popcorn*. I'm drinking *lemonade*.
- 2 I'm eating *pasta*. I'm drinking *juice*.
- 3 I'm eating *soup* and *salad*. I'm drinking *milk*.

## Unit 6 Reinforcement 2

### 1 Circle and write.

- 1 making posters
- 2 dressing up
- 3 playing music
- 4 acting
- 5 painting

### 2 Look and write.

- 1 I like *dressing up*.
- 2 I like *playing music*.
- 3 I like *acting*.
- 4 I don't like *making posters*.
- 5 I don't like *painting*.

## Unit 1 Extension 1

### 1 Look and write.

- 1 bathroom
- 2 hall
- 3 bedroom
- 4 garden
- 5 garage
- 6 kitchen
- 7 living room
- 8 dining room

### 2 Look and write.

- 1 *He's in the garden. She's in the bathroom.*
- 2 *She's in the bedroom. He's in the living room.*
- 3 *He's in the hall. She's in the kitchen.*
- 4 *She's in the garage. He's in the dining room.*

## Unit 1 Extension 2

### 1 Write.

- 1 bath
- 2 sofa
- 3 table
- 4 cupboard
- 5 bed

### 2 Look and write.

- 1 The cat is *on* the *bed*.
- 2 The book is *under* the *bed*.
- 3 The bag is *in* the *cupboard*.
- 4 The dog is *on* the *cupboard*.
- 5 The *bath* is *in* the *house*.
- 6 *The sofa* is *under* the *table*.

## Unit 2 Extension 1

### 1 Write and match.

- 1 play football - e
- 2 ride a bike - a
- 3 climb - b
- 4 read - c
- 5 write - d
- 6 draw - h
- 7 catch - f
- 8 hop - g

### 2 Look, circle and write.

- 1 She can't *climb*.
- 2 He can't *ride a bike*.
- 3 She can *read*.
- 4 He *can* write.
- 5 He *can't* catch.
- 6 She *can* draw.

## Unit 2 Extension 2

### 1 Write. Find and circle.

- 1 gym
- 2 toilet
- 3 classroom
- 4 bike shed
- 5 playground

### 2 Look and write.

- 1 She *is* in the classroom.
- 2 He *isn't* in the bike shed.
- 3 She *isn't* in the toilet.
- 4 He *is* in the gym.
- 5 *She is* in the playground.
- 6 *He isn't* in the gym.

## Unit 3 Extension 1

### 1 Look and write the differences.

- 1 farm
- 2 rainbow
- 3 tree
- 4 river
- 5 hill
- 6 road
- 7 rock
- 8 lake

### 2 Look at picture A and answer *Yes, I can* or *No, I can't*.

- 1 Yes, I can.
- 2 No, I can't.
- 3 Yes, I can.
- 4 Yes, I can.
- 5 No, I can't.
- 6 No, I can't.
- 7 Yes, I can.
- 8 No, I can't.

## Unit 3 Extension 2

### 1 Look and write.

- 1 owl
- 2 spider
- 3 fox
- 4 deer
- 5 hedgehog

### 2 Look and write.

- 1 The fox is *next* to the deer.
- 2 The hedgehog is *behind* the rock.
- 3 The deer is *behind* the tree.
- 4 The owl is *in front* of the tree.
- 5 The spider is *in front* of the rock.
- 6 The fox is *behind* the rock.
- 7 The owl is *next* to the road.
- 8 The deer is *in front* of the lake.

## Unit 4 Extension 1

### 1 Write. Find and circle.

- 1 blond hair
- 2 freckles
- 3 long hair
- 4 short hair
- 5 eyebrows
- 6 blue eyes
- 7 glasses
- 8 dark hair

### 2 Write. Read, draw and colour.

- 1 She's got *glasses*.
- 2 She's got long *hair*.
- 3 She's got *dark* hair.
- 4 She's got blue *eyes*.
- 5 He's got *freckles*.
- 6 He's got blond *hair*.
- 7 He's got *short* hair.
- 8 He's got brown *eyes*.

## Unit 4 Extension 2

### 1 Write and match.

- 1 coat
- 2 scarf
- 3 boots
- 4 shorts
- 5 jeans

### 2 Write.

- 1 She's wearing *shorts*.
- 2 He's wearing a *coat* and a *scarf*.
- 3 She's wearing a *coat* and *boots*.
- 4 He's wearing *shorts*.
- 5 *She's wearing jeans*.
- 6 *He's wearing a coat and jeans*.

## Unit 5 Extension 1

### 1 Look and write. Count.

- a 10 bees
- b 1 donkey
- c 4 chickens
- d 3 sheep
- e 2 pigs
- f 1 goat
- g 1 cow
- h 5 ducks

### 2 Look and write.

- a There are 10 bees.
- b There is 1 donkey.
- c There are 4 chickens.
- d There are 3 sheep.
- e There are 2 pigs.
- f There is 1 goat.
- g There is 1 cow.
- h There are 5 ducks.

## Unit 5 Extension 2

### 1 Look and write. Match.

- 1 wings
- 2 feet
- 3 ears
- 4 feathers
- 5 teeth

### 2 Look and write.

- 1 It's got 2 wings.  
It's got 2 feet.  
It hasn't got ears.  
It hasn't got teeth.
- 2 It's got 4 feet.  
It's got 2 ears.  
It hasn't got wings.  
It hasn't got feathers.

## Unit 6 Extension 1

### 1 Look and write. Complete the table.

- 1 salad
- 2 popcorn
- 3 juice
- 4 pizza
- 5 lemonade
- 6 milk
- 7 pasta
- 8 soup

**Food:** salad, popcorn, pizza, pasta, soup

**Drink:** juice, lemonade, milk

### 2 Write.

I'm *drinking milk and lemonade*. I'm *eating pizza*.  
I'm *drinking juice*. I'm *eating pasta and soup*.

## Extension 2 Unit 6

### 1 Match and write.

- 1 dressing up
- 2 acting
- 3 painting
- 4 making posters
- 5 playing music

### 2 Look and write.

- 1 I like acting.
- 2 I don't like dressing up.
- 3 I don't like playing music.
- 4 I like making posters.
- 5 I like painting.

### 3 Write 2 sentences for you.

Children's own answers.