

1 Match and draw.

2 Trace.

1

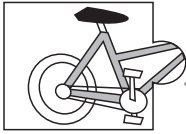

bi

2



do

3

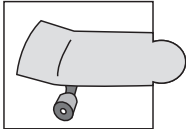

skate

4

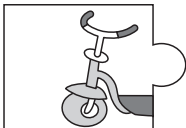

scoo

5



ba

6

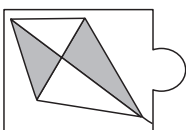

ki

7

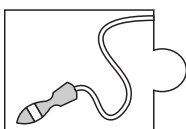

skipping

8

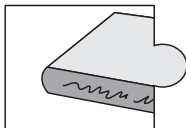

bo

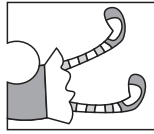

ll



ll

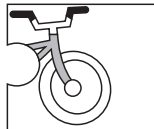

ke

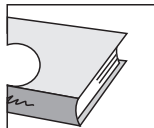

ok

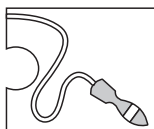

rope

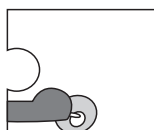

ter

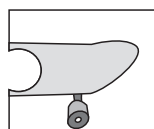

board

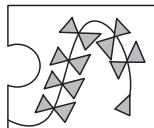

te

ball

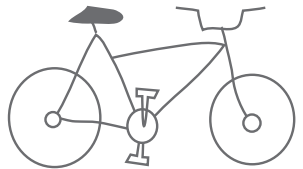
bike 

doll

scooter

book

skipping rope

kite

skateboard

1 Look, read and tick ✓.



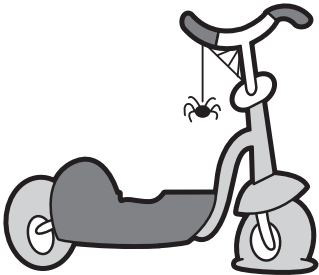

1  ball
 bike
 big
 small

2  scooter
 doll
 old
 new

3  book
 kite
 big
 small

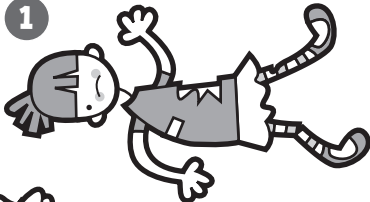
4  bike
 scooter
 old
 new

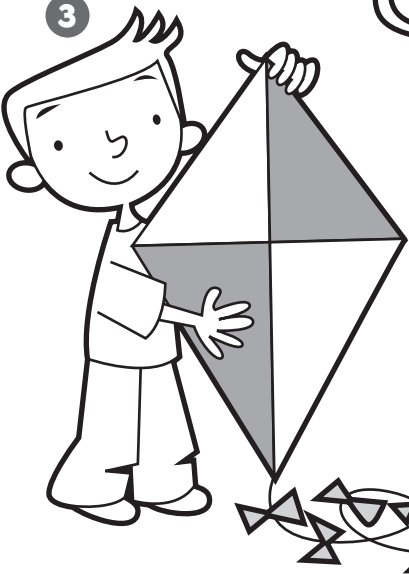
2 Trace. Look, read and number.

1  big
 2  small
 3  old
 4  new

1 Follow and trace. Tick ✓ or cross X.



1   frog

2   horse

3   bird

4   dog

5   fish

6   rabbit

7   mouse

8   cat

1 Look, read and tick ✓.

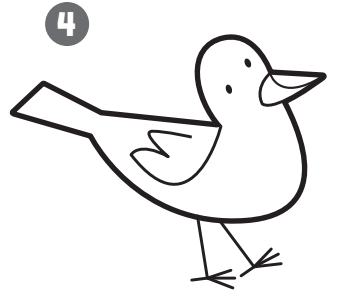
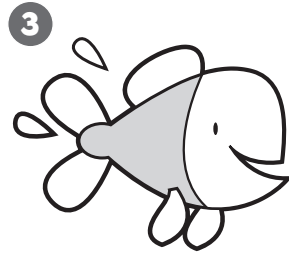
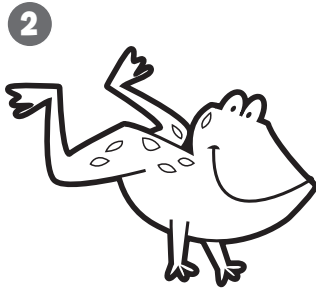
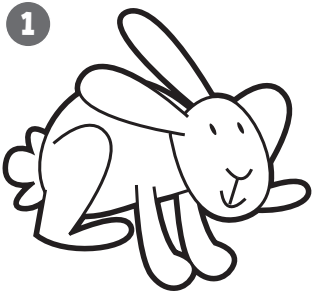

body
 tail
 nose
 legs

body
 tail
 nose
 legs

body
 tail
 nose
 legs

body
 tail
 nose
 legs

2 Trace. Look and number.

body
 tail
 nose
 legs

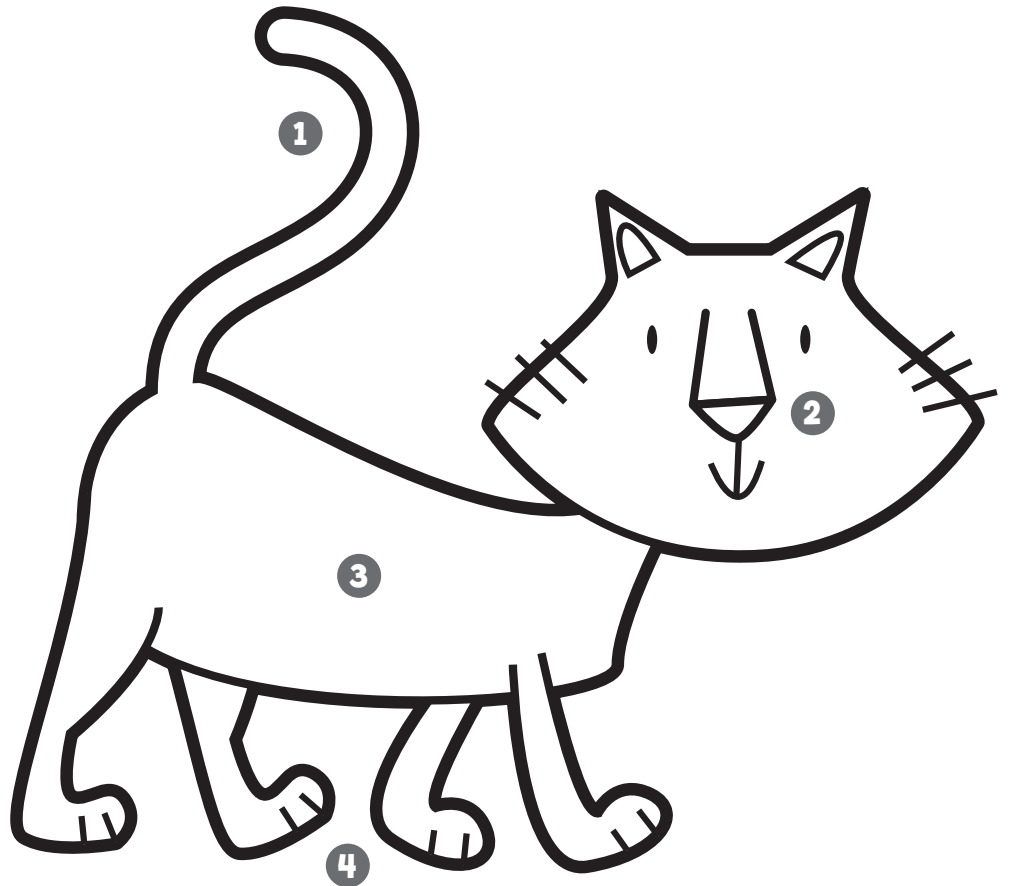

1 Complete. Read and circle.

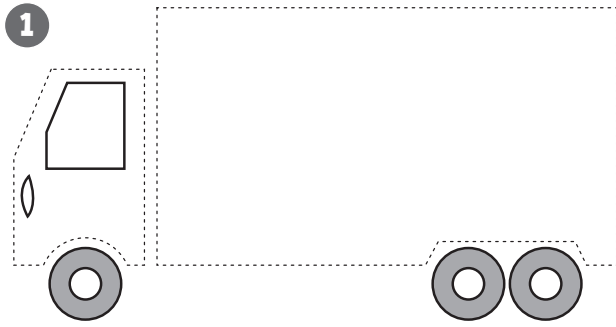

taxi lorry

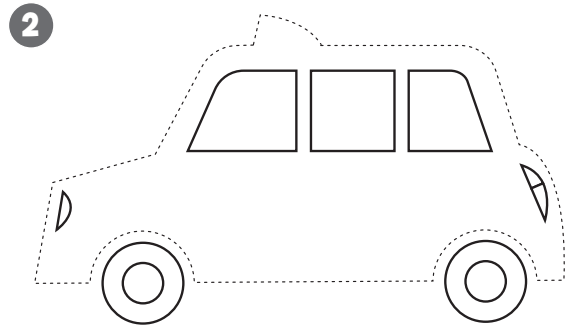

taxi train

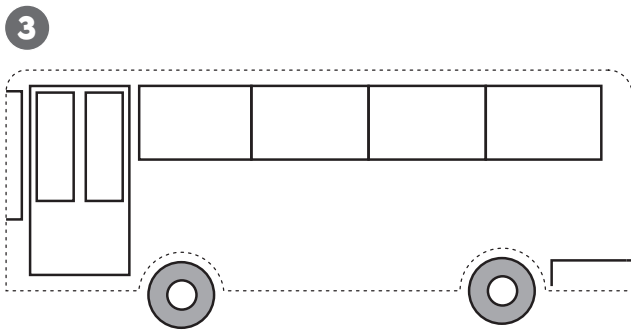

plane bus

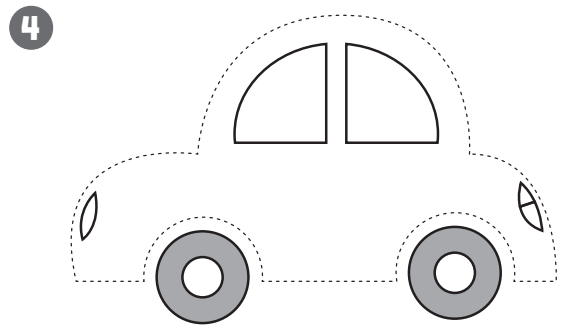

motorbike car

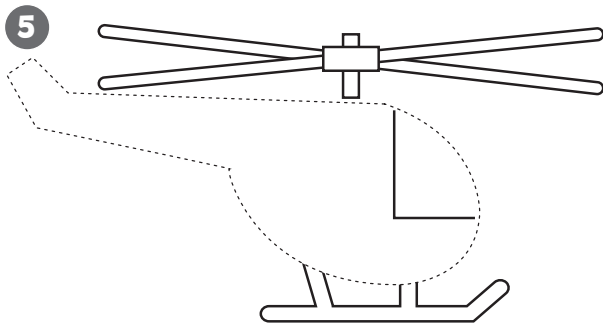

helicopter taxi

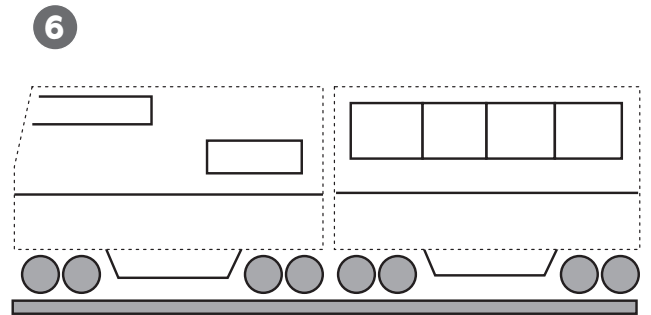

train lorry

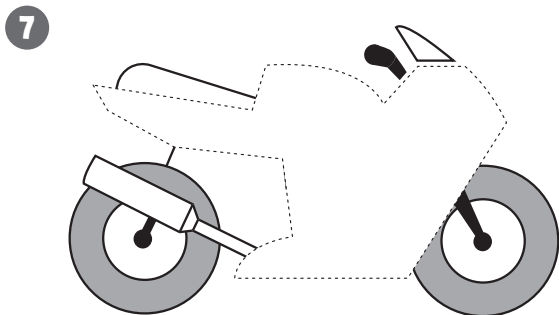

bus motorbike

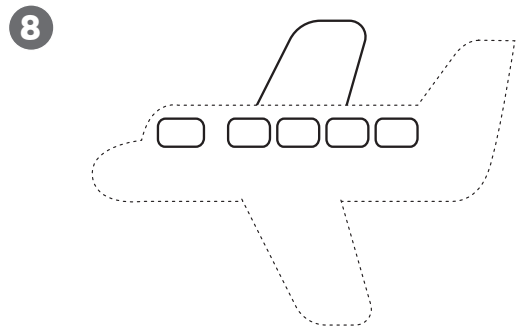

car plane

1 What's next? Match and write.

1



walk



eat



walk



eat



2



run



shout



run



shout



3



eat



eat



run



run



4



walk



shout



run



walk



1 Look and number.

- 1 brother
- 2 mum
- 3 grandma
- 4 dad
- 5 sister
- 6 grandpa
- 7 uncle
- 8 aunty

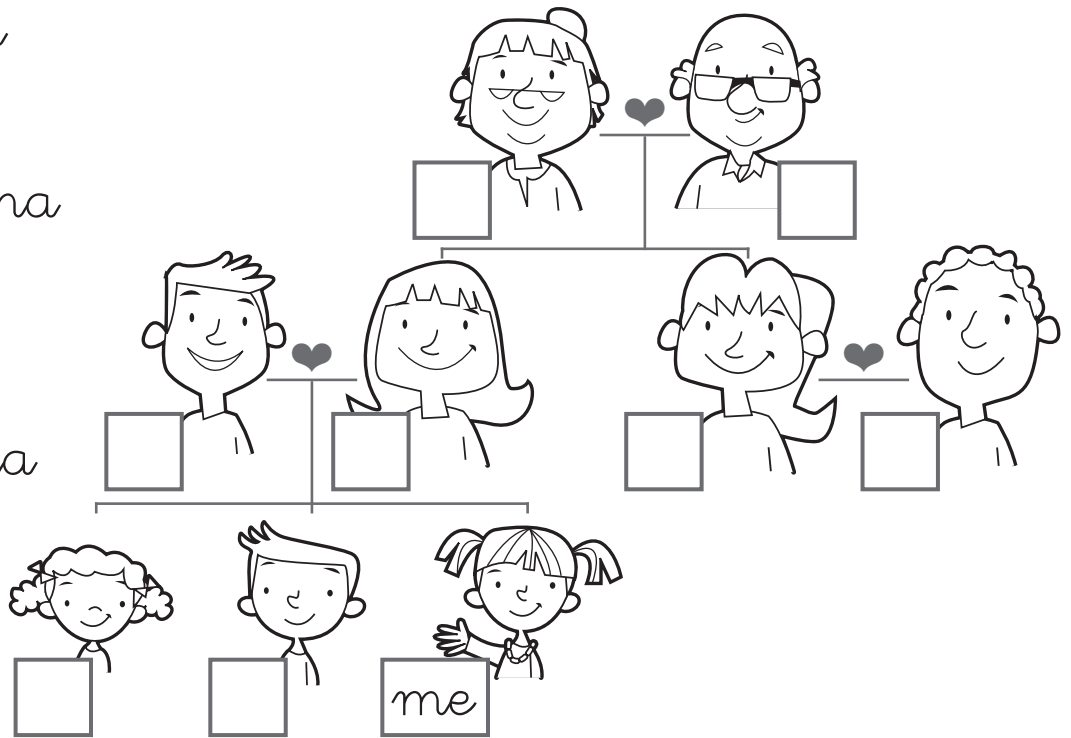

2 Write. Read and circle.



gr__ndm__
m__m

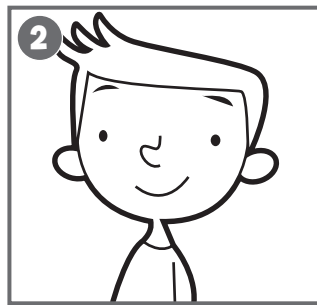

br__th__r
s__st__r

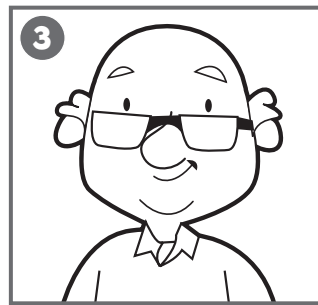

m__m
gr__ndp__

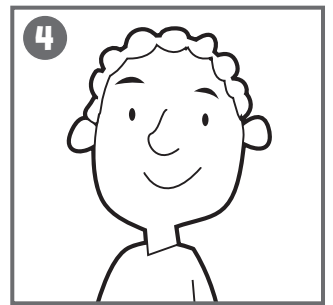

s__st__r
__ncl__

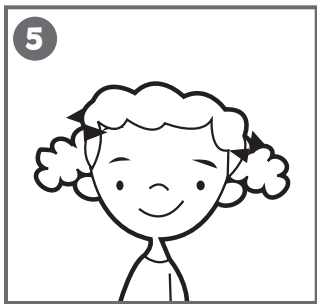

d__d
s__st__r

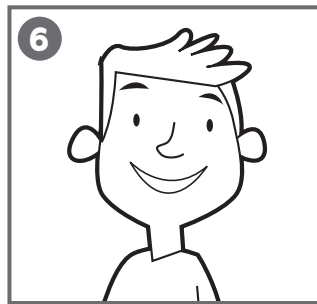

gr__ndm__
d__d



m__m
br__th__r

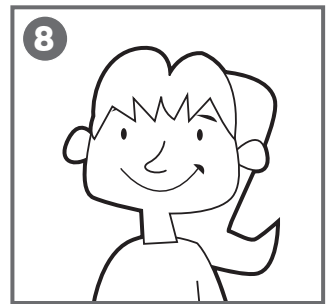

__nty
d__d

1 Match.

skip

jump

sing

dance



2 Complete and write.



He can _____.

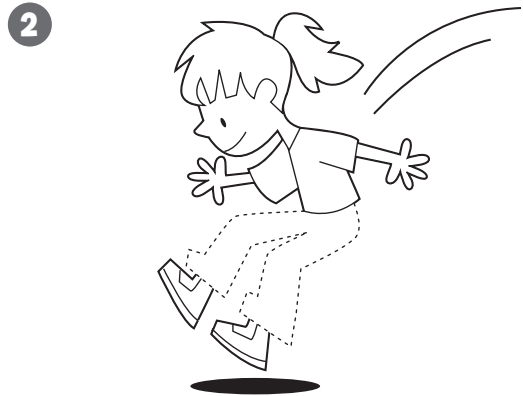

She can _____.

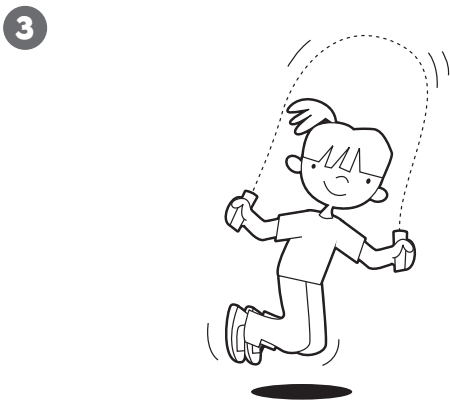

She can _____.



He can _____.

1 Circle and write.

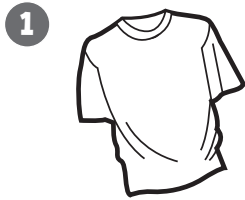

T-shirt

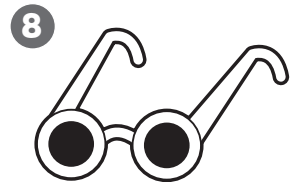
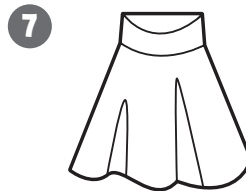
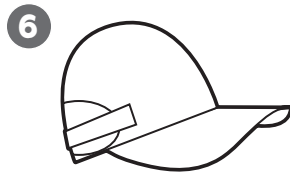
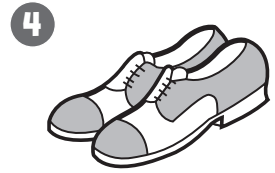
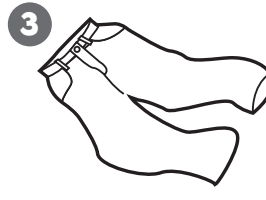
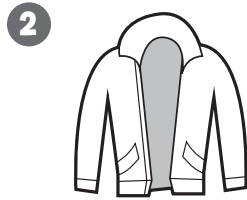

2 Look and write. Read and colour.

1 I'm wearing a blue
jacket

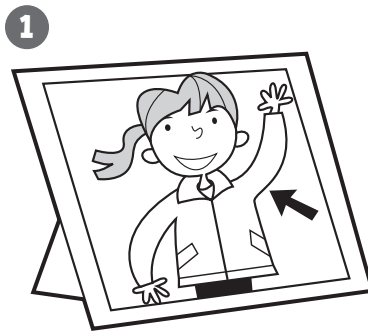

2 I'm wearing green

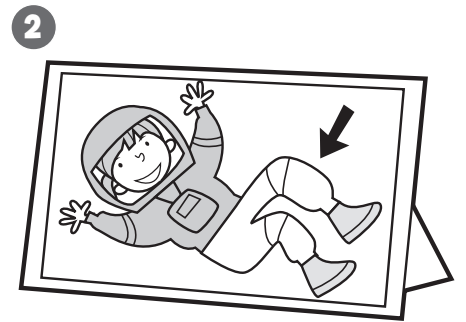

3 I'm wearing a red



4 I'm wearing purple

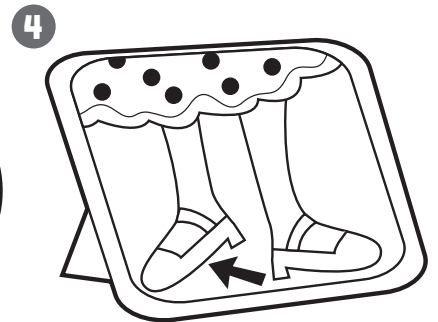

1 Follow and draw.

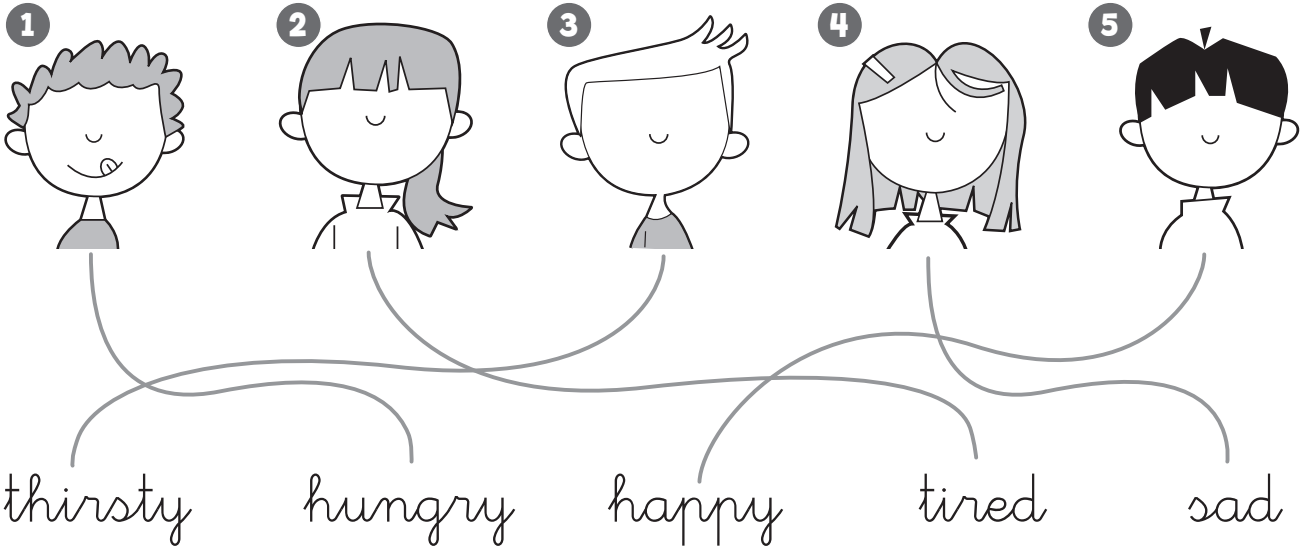

2 Match and write.

1	h a p p y	t i _ _ d	
2	t h i r s t y	h a p p y	
3	t i r e d	s _ d	
4	h u n g r y	t _ _ _ t y	
5	s a d	h _ _ _ y	

1 Join and trace. Count and write.

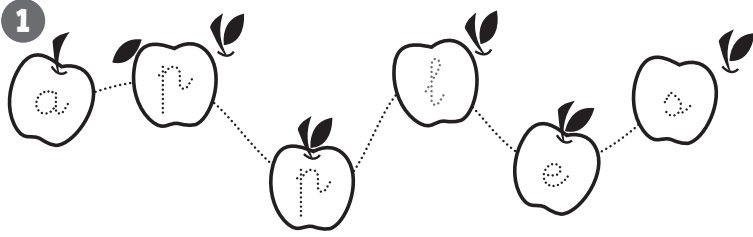

apples

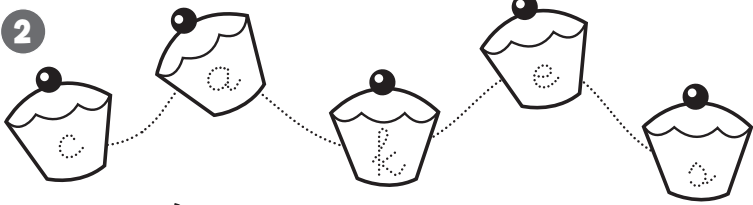

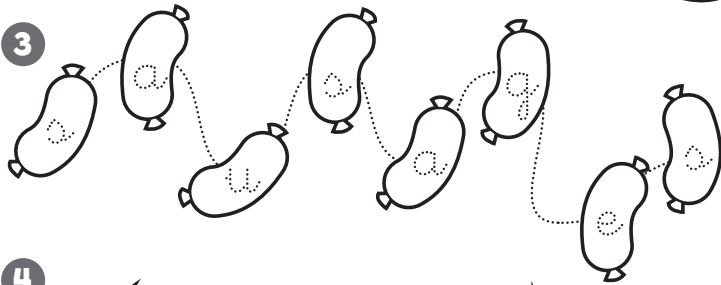

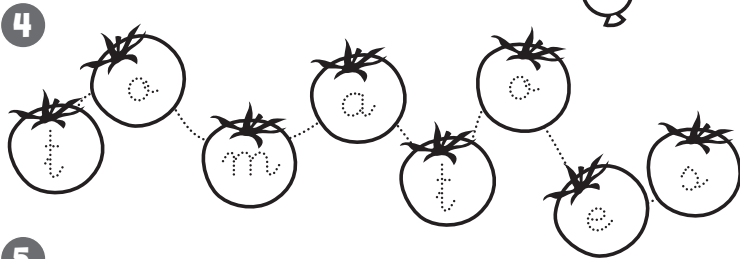

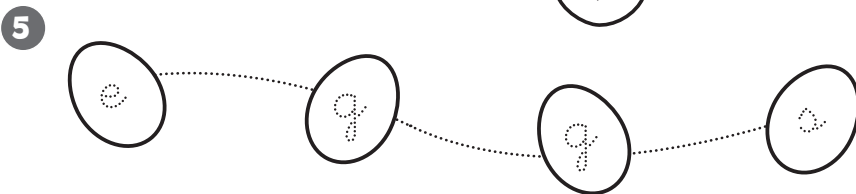

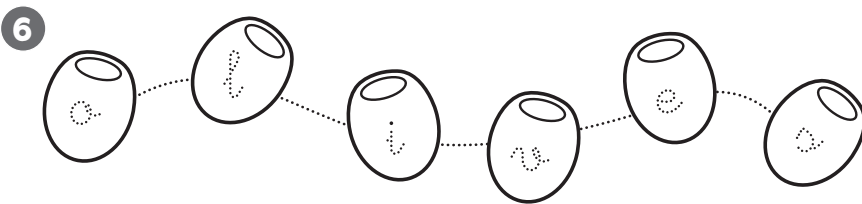



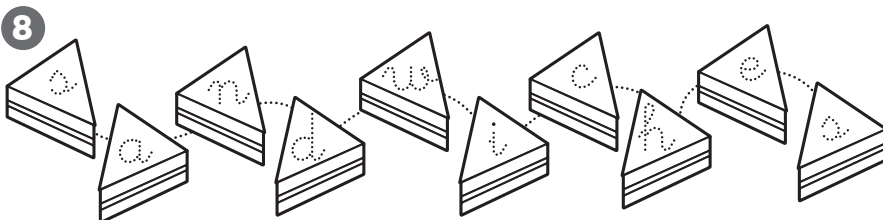

1 Read and colour. Look and write. **2** Draw 😊 or ☹️ for you.

apples = green olives = black
 cherries = pink oranges = orange
 pears = yellow grapes = purple
 peaches = white strawberries = red

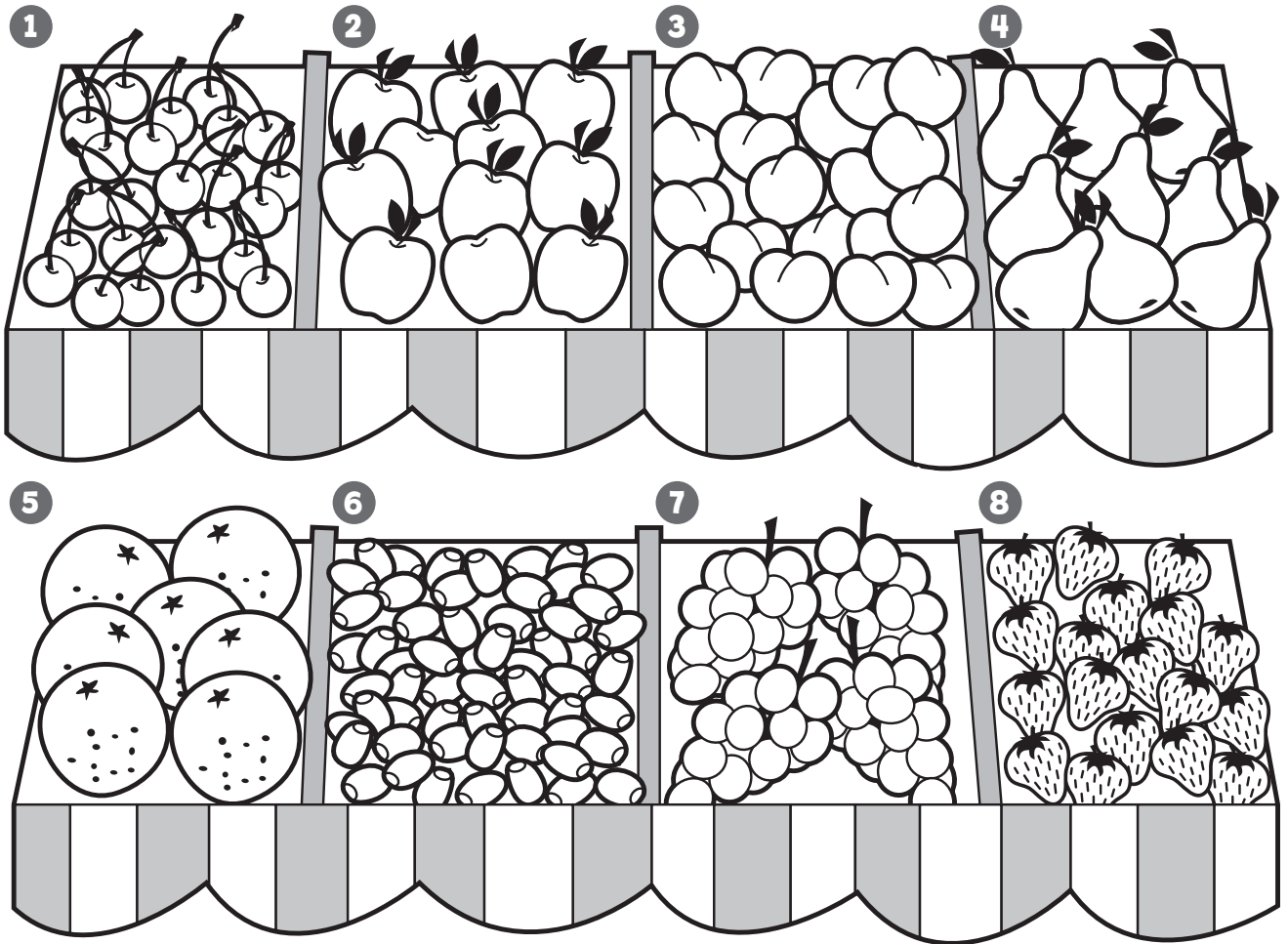

1 _____ 😊

2 _____ 😊

3 _____ 😊

4 _____ 😊

5 _____ 😊

6 _____ 😊

7 _____ 😊

8 _____ 😊

1 Look and draw. Write.

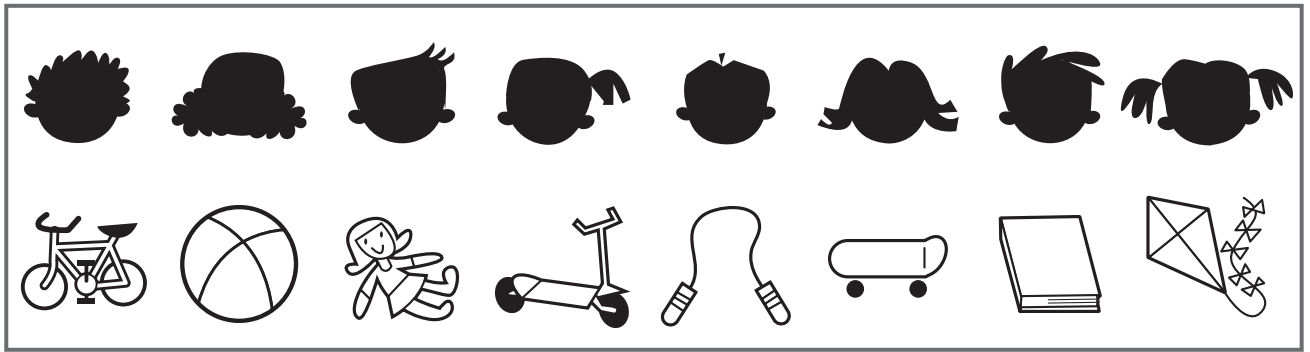

1 I've got a bike.

2 I've got a _____.

3 I've got a _____.

4 I've got a _____.

5 I've got a _____.

6 I've got a _____.

7 I've got a _____.

8 I've got a _____.

ball kite skateboard book ~~bike~~
skipping rope doll scooter

1 Follow and write.

ball ~~book~~ doll scooter
big new old ~~small~~

1



I've got a book.

It's small.

2



I've got a _____.

It's _____.

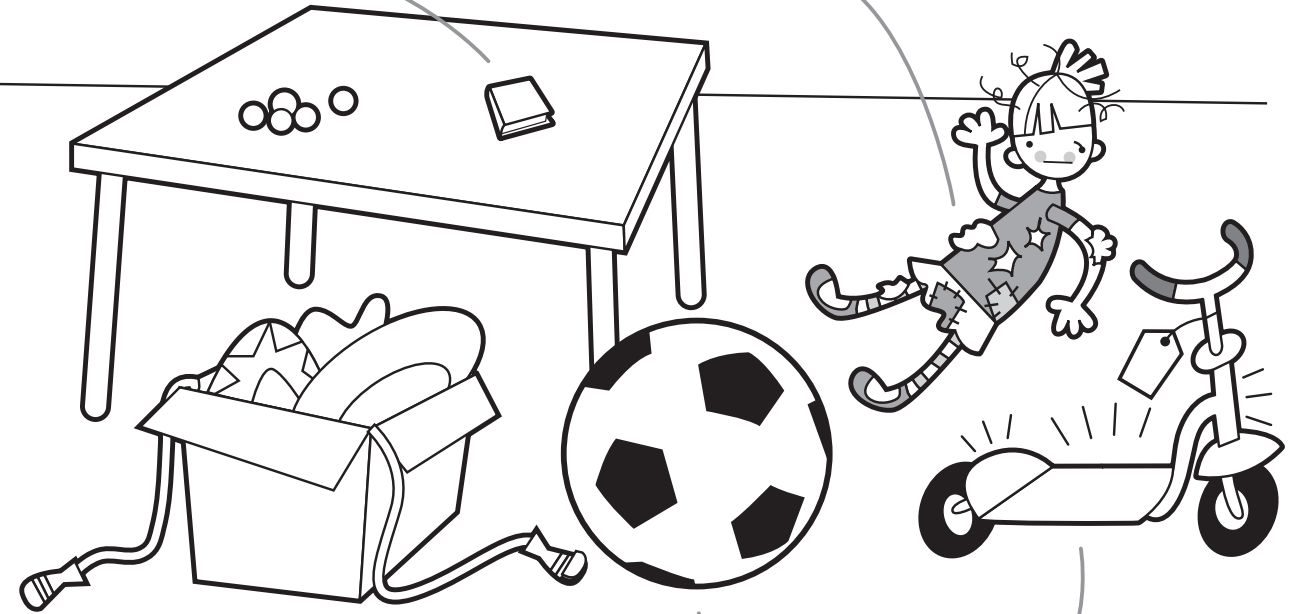

3

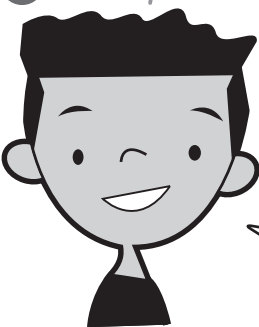

I've got a _____.

It's _____.

4



I've got a _____.

It's _____.

1 Complete and write.

bird cat dog fish
frog horse mouse rabbit

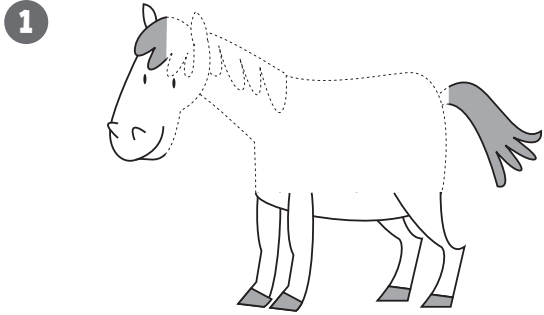

It's a horse.

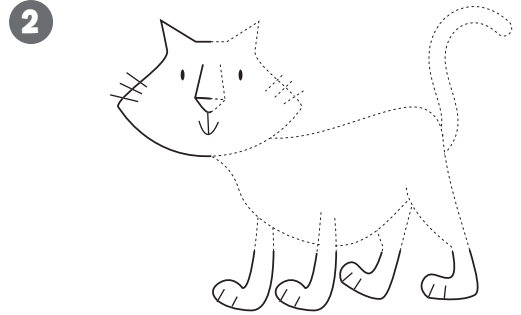

It's a _____.

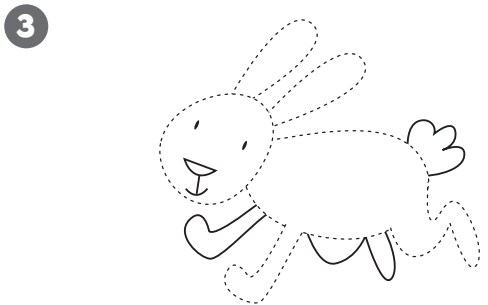

It's a _____.

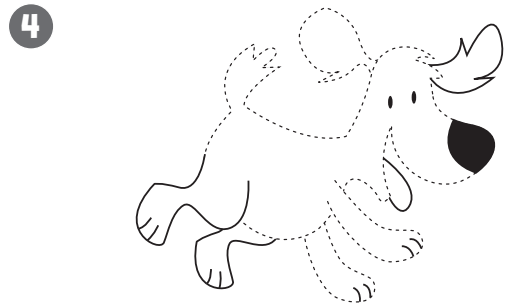

It's a _____.

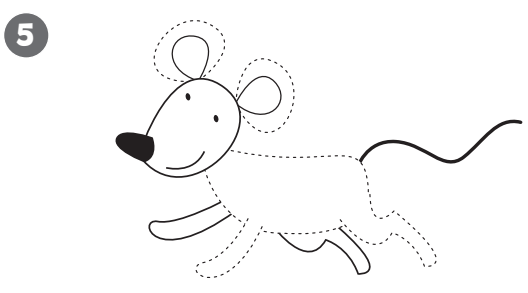

It's _____.

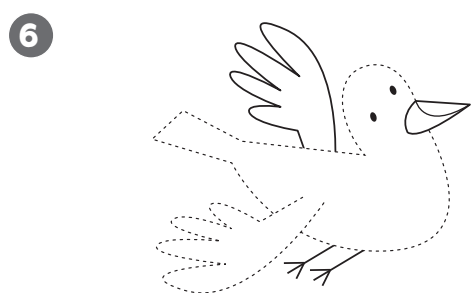

It's _____.

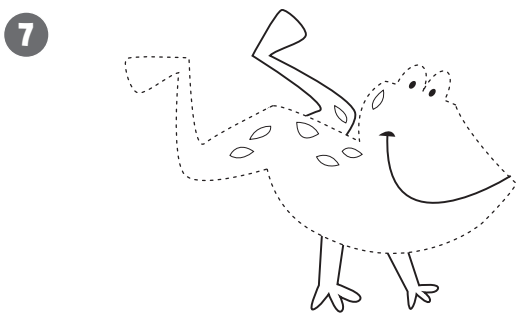

_____.

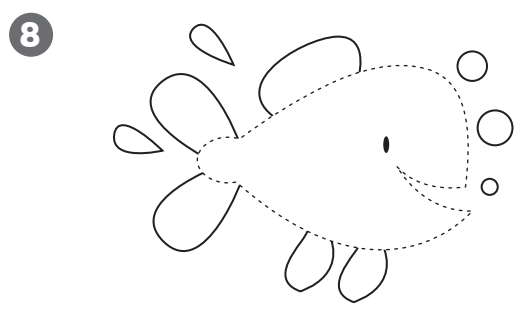

_____.

1 Match and write. Read and colour.

1

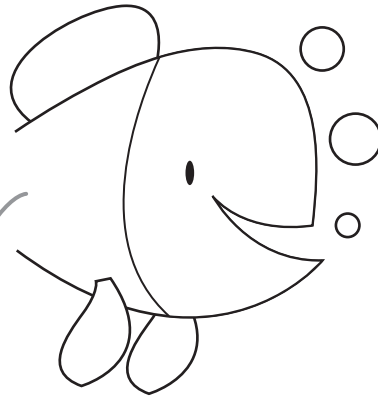

It's a fish.

Look! A blue tail.

2

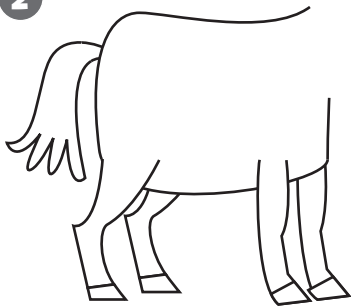

It's a _____.

Look! A brown body.

3

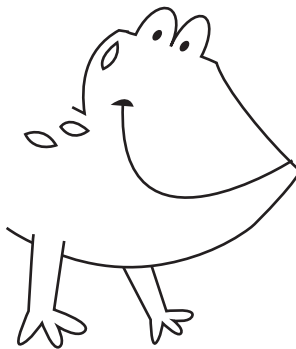
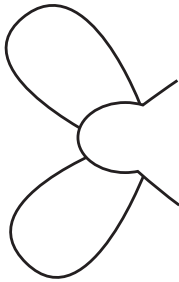

It's a _____.

Look! Green legs.

4

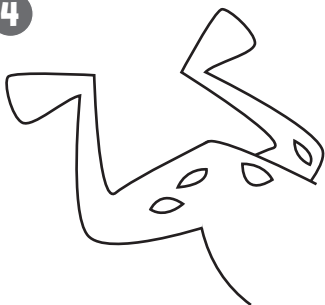

_____.

_____.

Look! A pink nose.

1 Look and write.

bus car helicopter lorry
motorbike plane taxi train

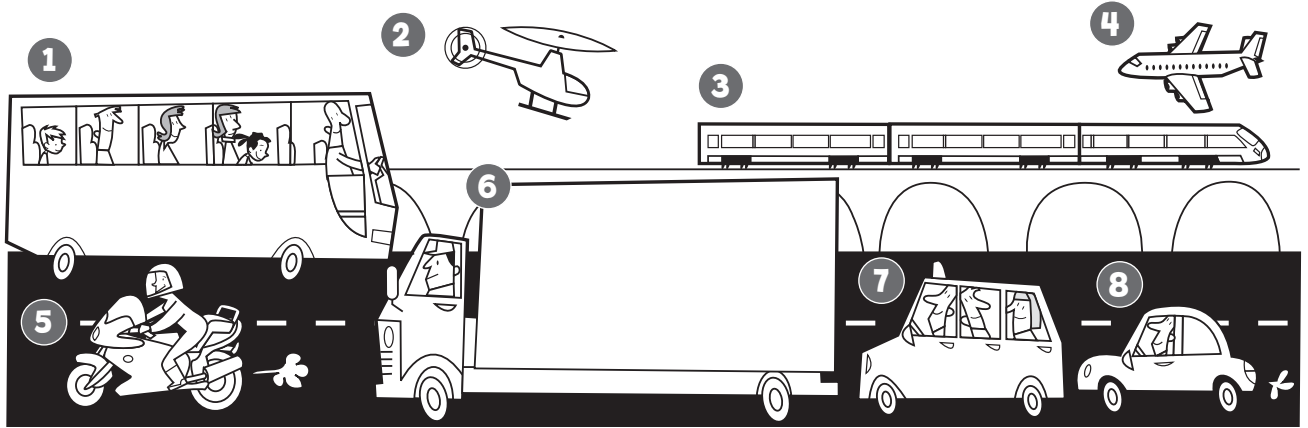

1 _____

5 _____

2 _____

6 _____

3 _____

7 _____

4 _____

8 _____

2 Look, colour and write.

■ = red ● = green ▲ = blue ◆ = orange



1 I can see a
_____ bus _____.
It's □ _____ red _____.

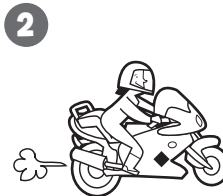

2 I can see a
_____.
It's ◆ _____.



3 I can see a
_____.
It's ▲ _____.



4 I can see a
_____.
It's ○ _____.

1 Read and match.

1 Walk!

2 Run!

3 Eat!

4 Shout!

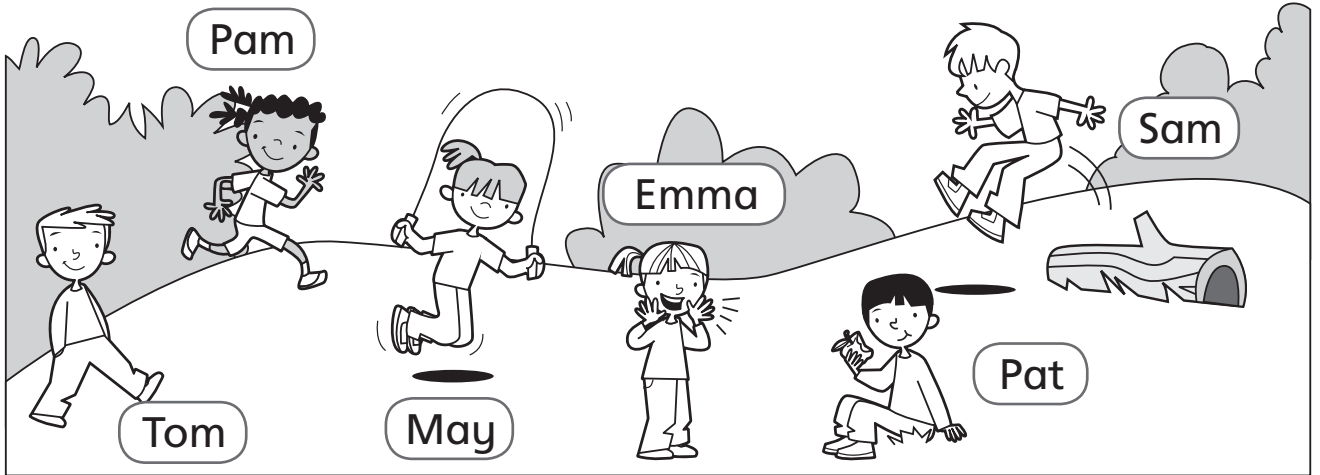

2 Write, match and number.

ou a Ea u e

1 W _ l k! _____

2 Don't r _ n!

3 Don't _ at!

4 Don't sh _ _ t!

5 _ _ t!

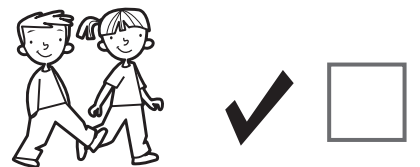

1 Look and write.

~~grandma~~ mum dad aunty brother
uncle sister grandpa

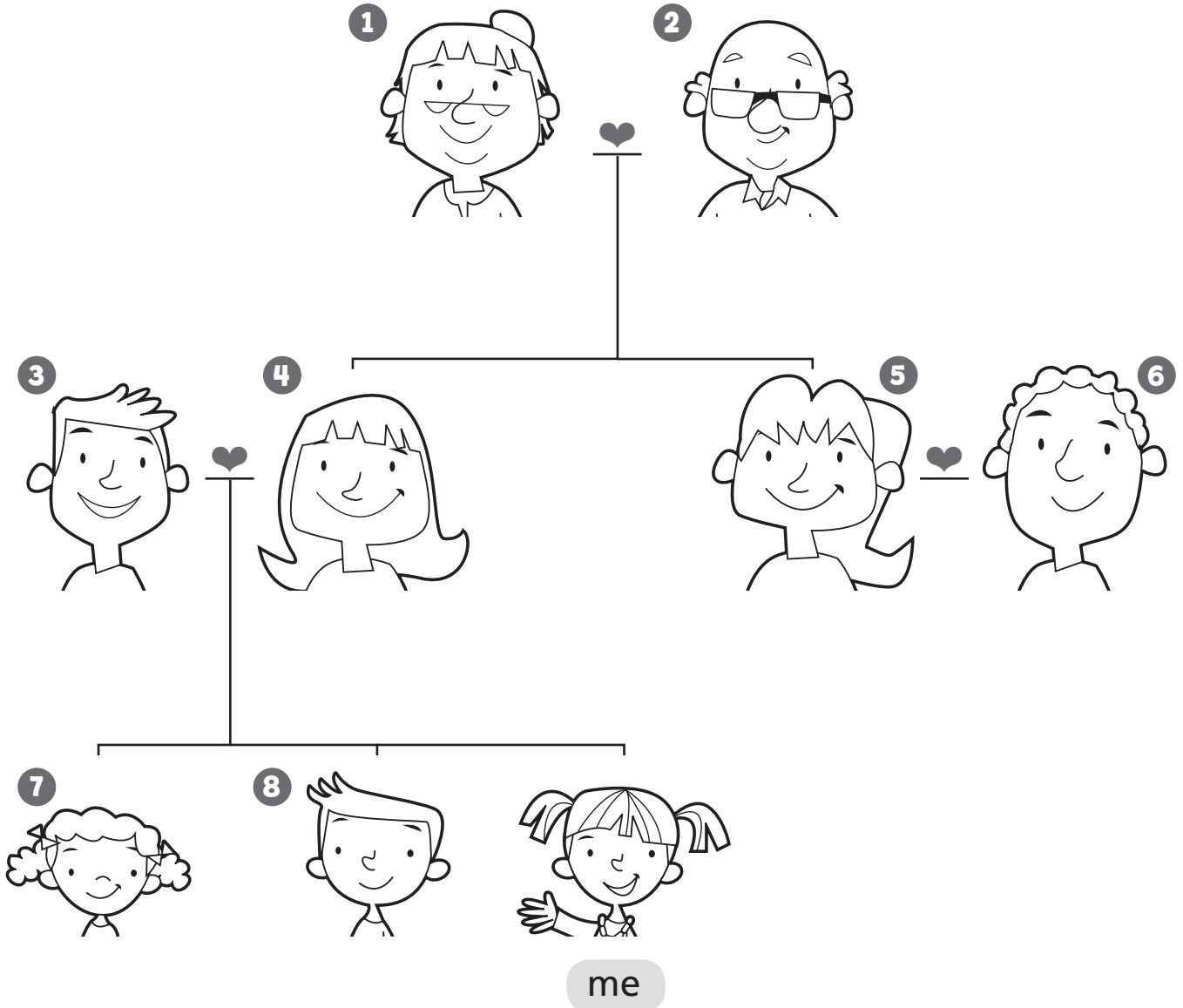

- 1 This is my grandma. 5 This is my _____.
- 2 This is my _____.
- 3 This is my _____.
- 4 This is my _____.
- 6 This is my _____.
- 7 This is _____.
- 8 _____.

1 Look and write.

brother ~~grandpa~~ mum sister
~~dance~~ jump sing skip



- 1 This is my grandpa. He can dance.
- 2 This is my _____. She can _____.
- 3 _____
- 4 _____

2 Draw and write about your friend.



1 Write.

cap dress jacket shoes ~~skirt~~
 sunglasses trousers T-shirt

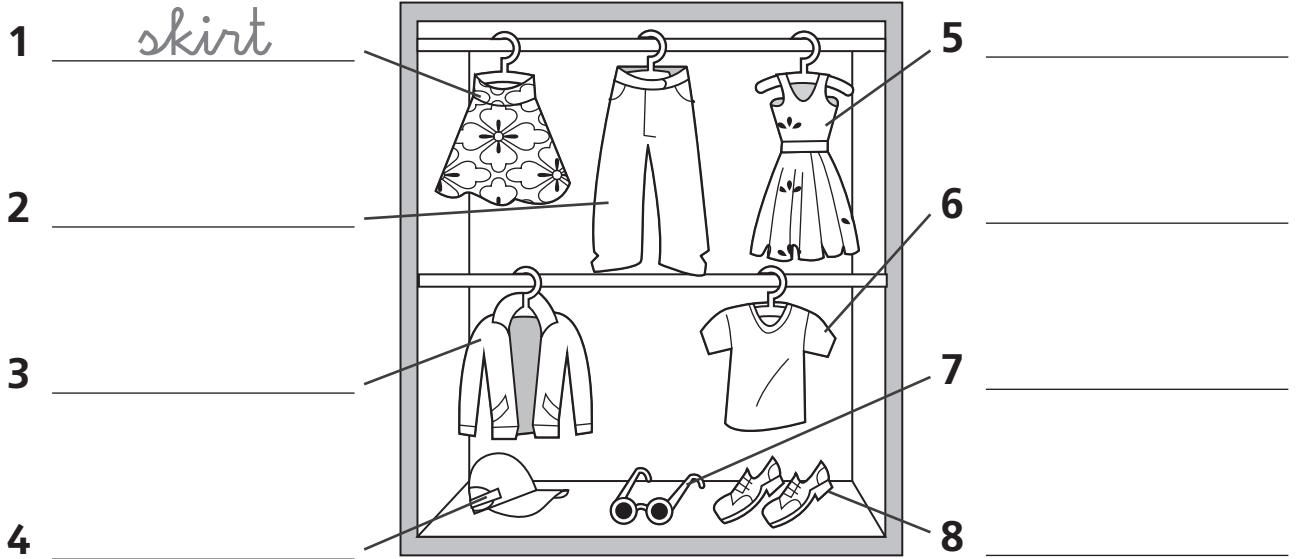

2 Look and write. Draw and write for you.

I'm wearing a dress and _____.

I'm wearing a _____ and _____.

I'm wearing _____.

1 Write and match.

happy hungry sad thirsty tired

1 She's s a d.



2 She's t ___ r ___ d.



3 She's h ___ ngr ___.



4 He's h ___ ngr ___.



5 She's h ___ pp ___.



6 He's t ___ r ___ d.



7 He's th ___ rst ___.



8 She's th ___ rst ___.



1 Look, circle and write.

apples cakes eggs olives sandwiches
sausages strawberries tomatoes



I like / don't like sausages.

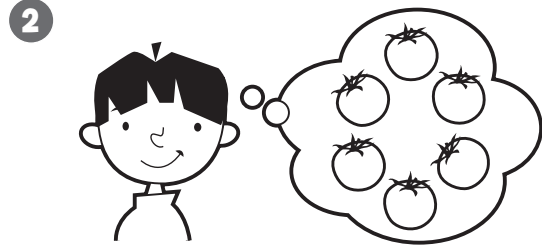

I like / don't like _____.



I like / don't like _____.



I like / don't like _____.

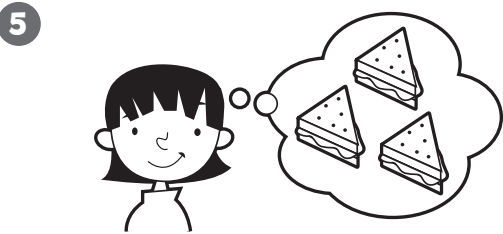

I like / don't like _____.

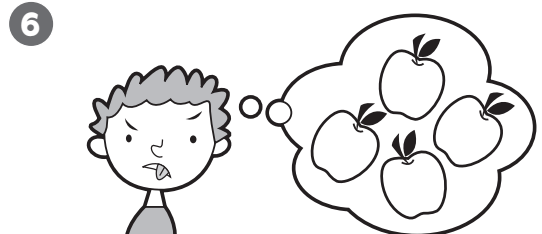

I like / don't like _____.

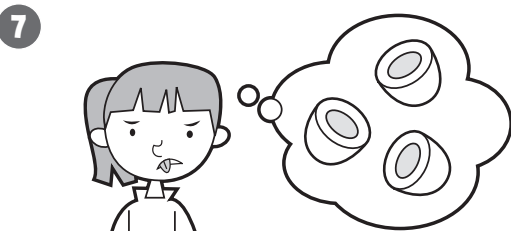

I like / don't like _____.



I like / don't like _____.

2 Count and colour.

3 = yellow 4 = green 5 = brown 6 = red

1 Follow and write.

2 Follow, draw and write for you.

~~cakes~~ cherries grapes olives
 oranges peaches

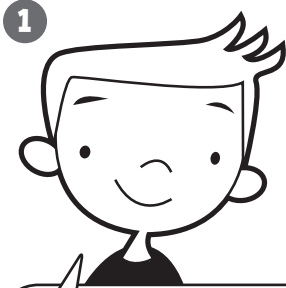

I like
cakes



I don't like

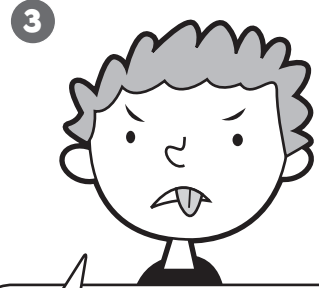

I _____

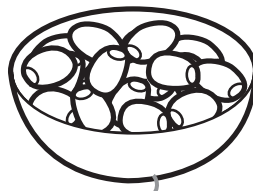
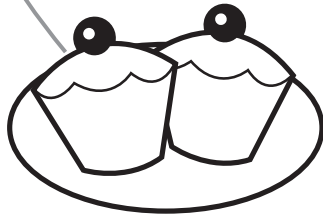
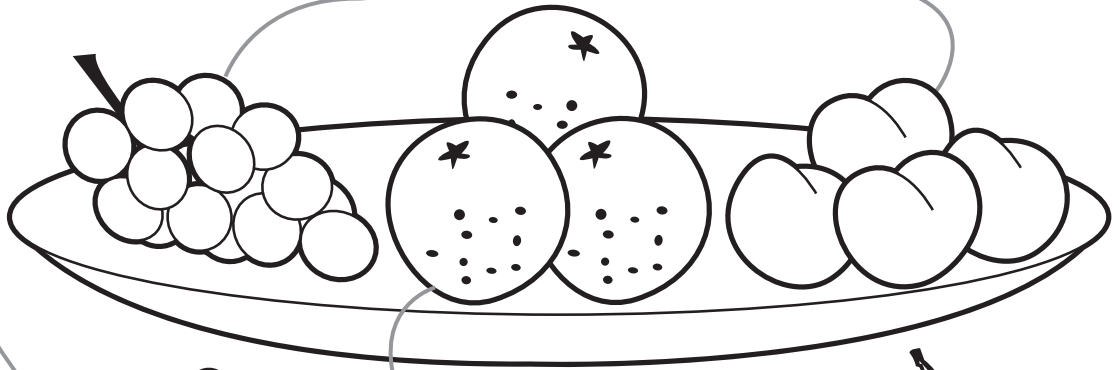

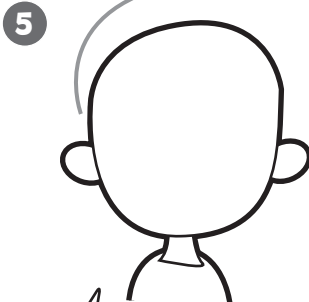

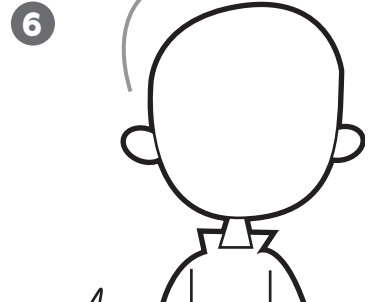



1 Match and trace.

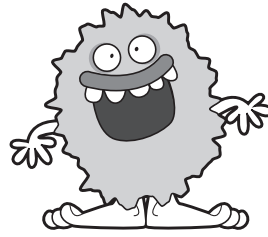
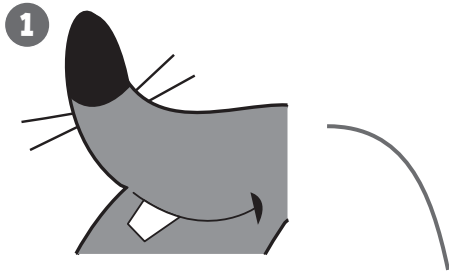

witch

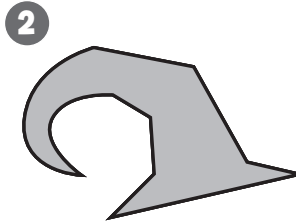

rat

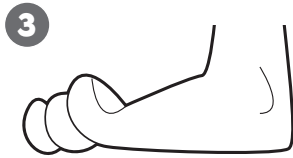

ghost

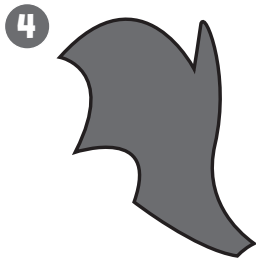

bat

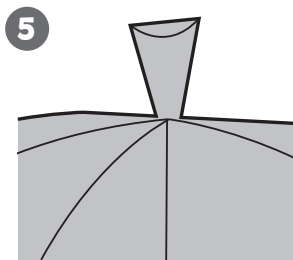

pumpkin

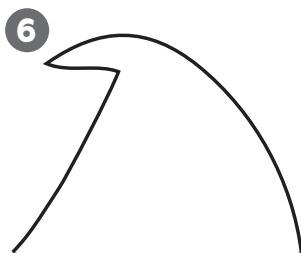

monster

1 Trace, count and write.



1 carrot

4 star

2 mince pie

5 stocking

3 present

6 tree



1 Look, trace and number.

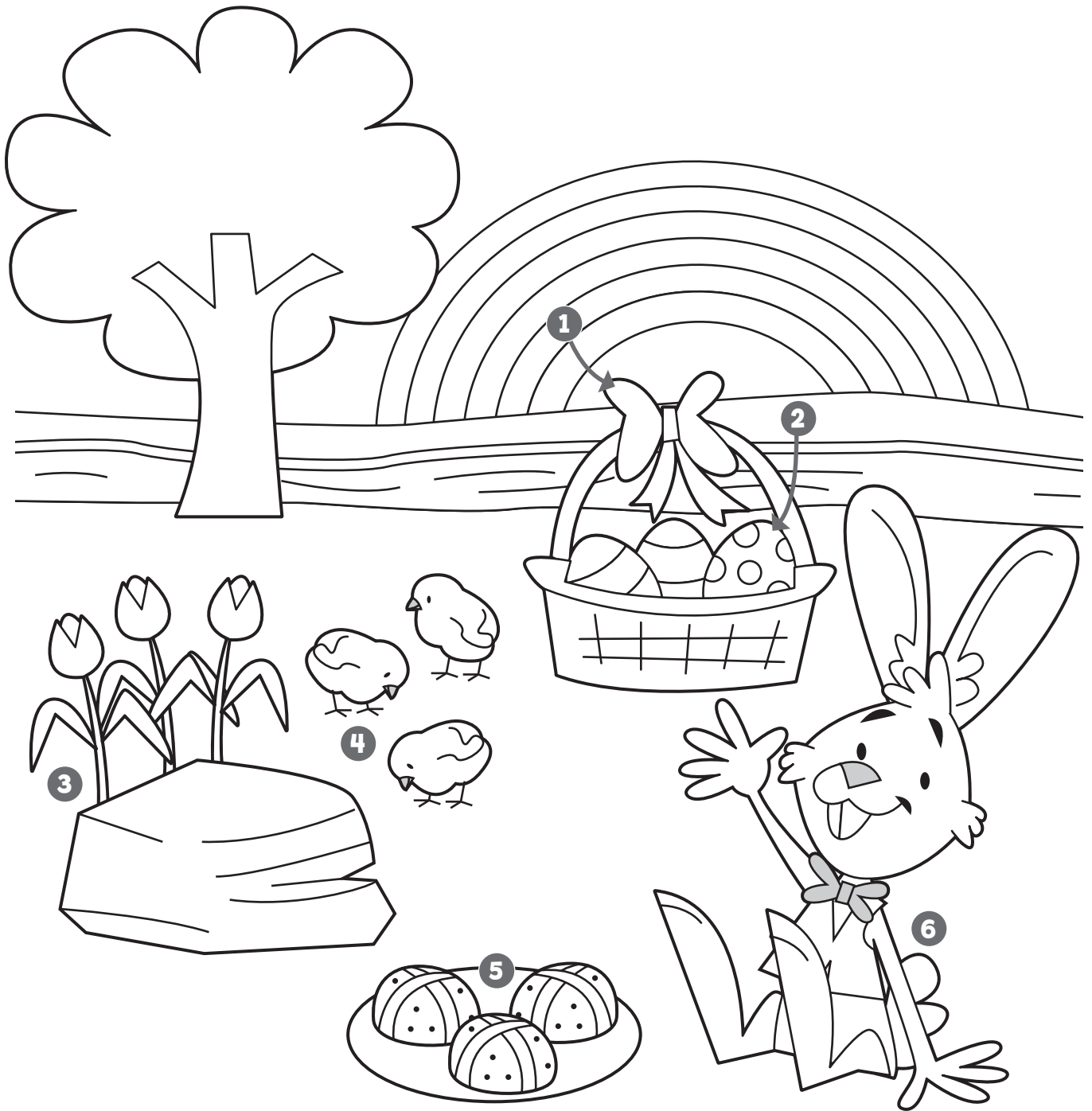

hot cross buns

chicks

basket

Easter bunny

Easter eggs

flowers



1 Look, number and write.

bat ghost monster pumpkin rat witch

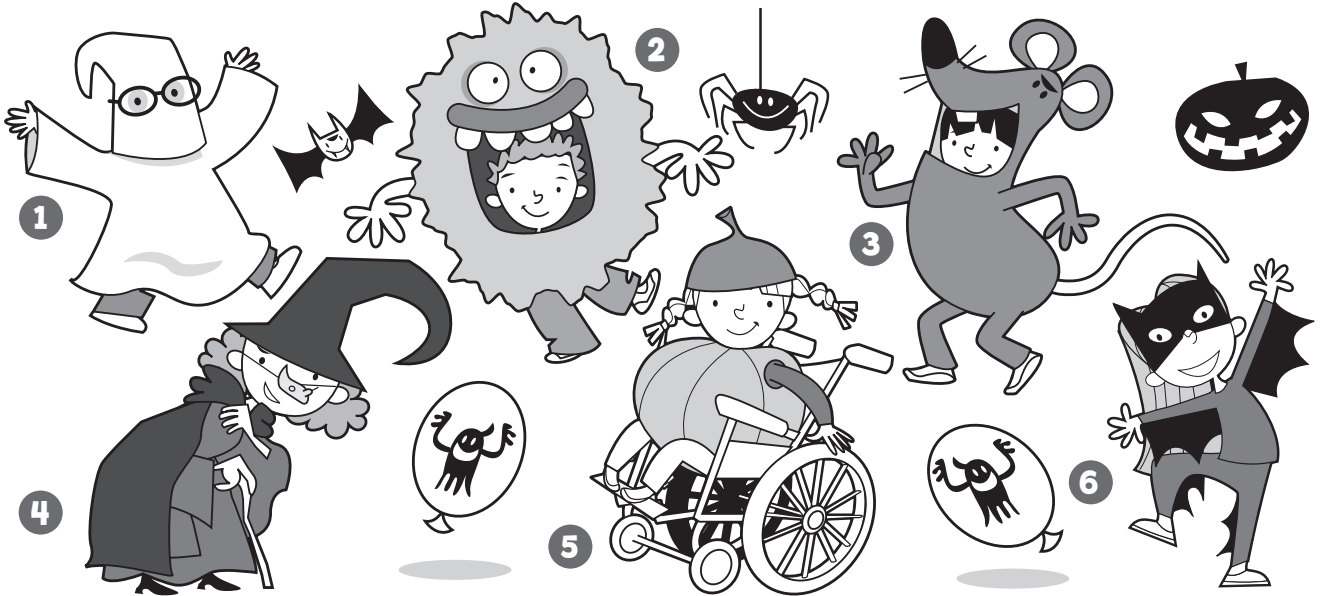

I'm a _____.



I'm a _____.



I'm a _____.



I'm a _____.



I'm a _____.



I'm a _____.



1 Look and write.

Easter bunny chicks flowers
hot cross buns basket Easter eggs

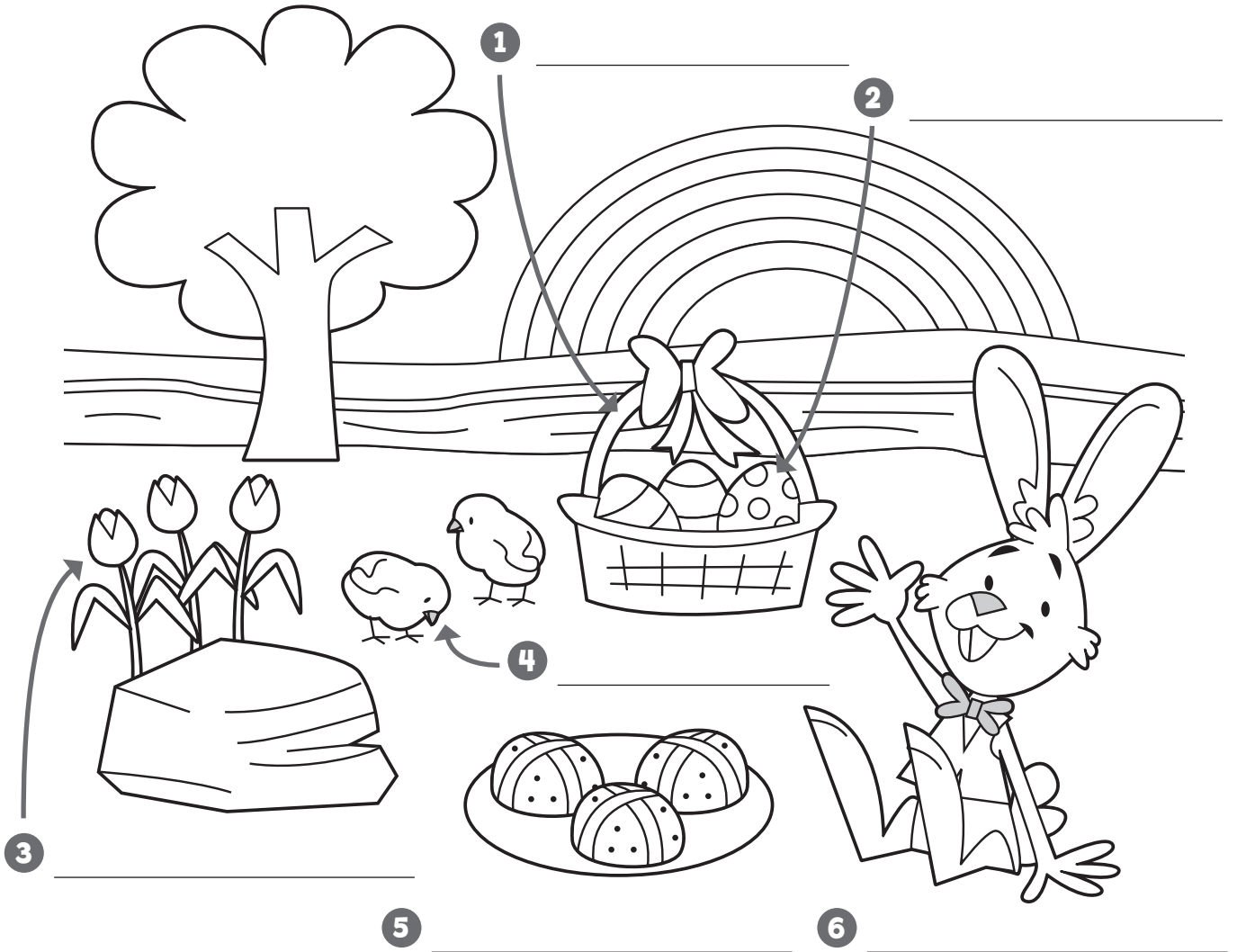

2 Look again and write.

1 I can see 1 _____.

2 I can see 3 _____.

3 _____

4 _____

5 _____

6 _____

Halloween

Cut-out



1 Make a monster mask.

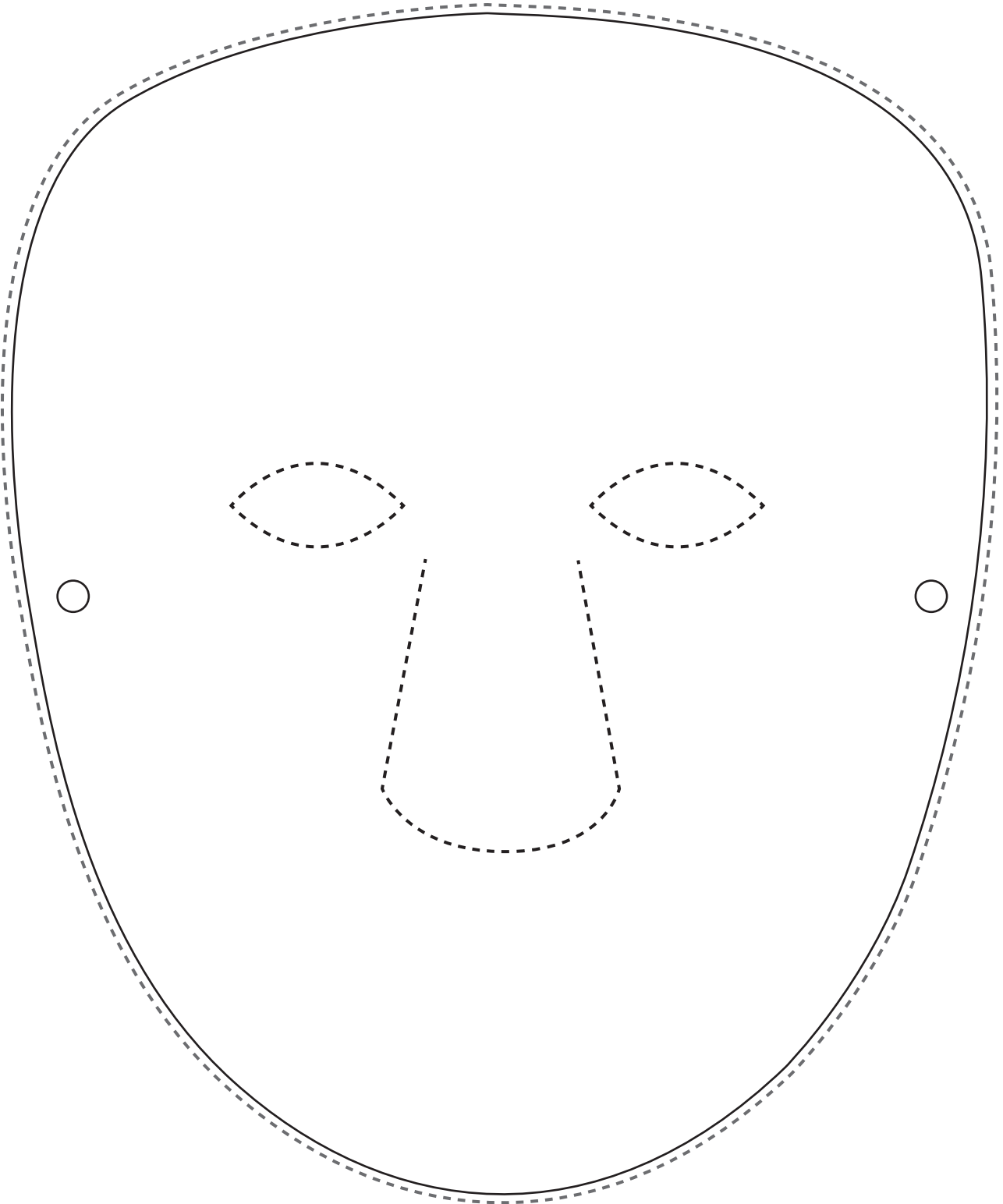

Christmas

Cut-out



1 Make a Christmas star.

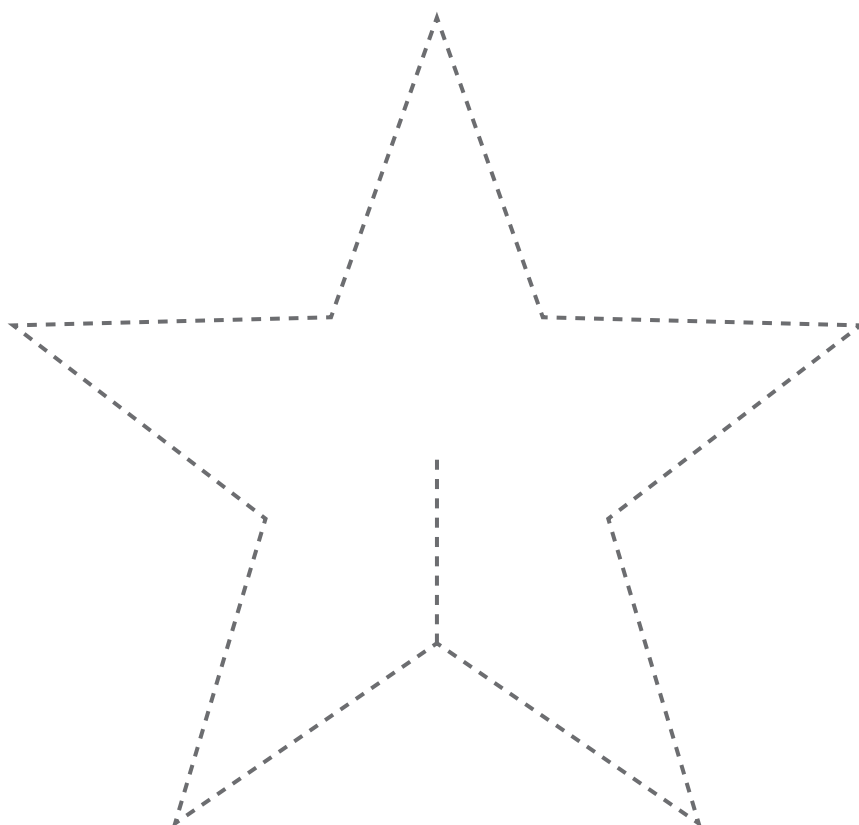
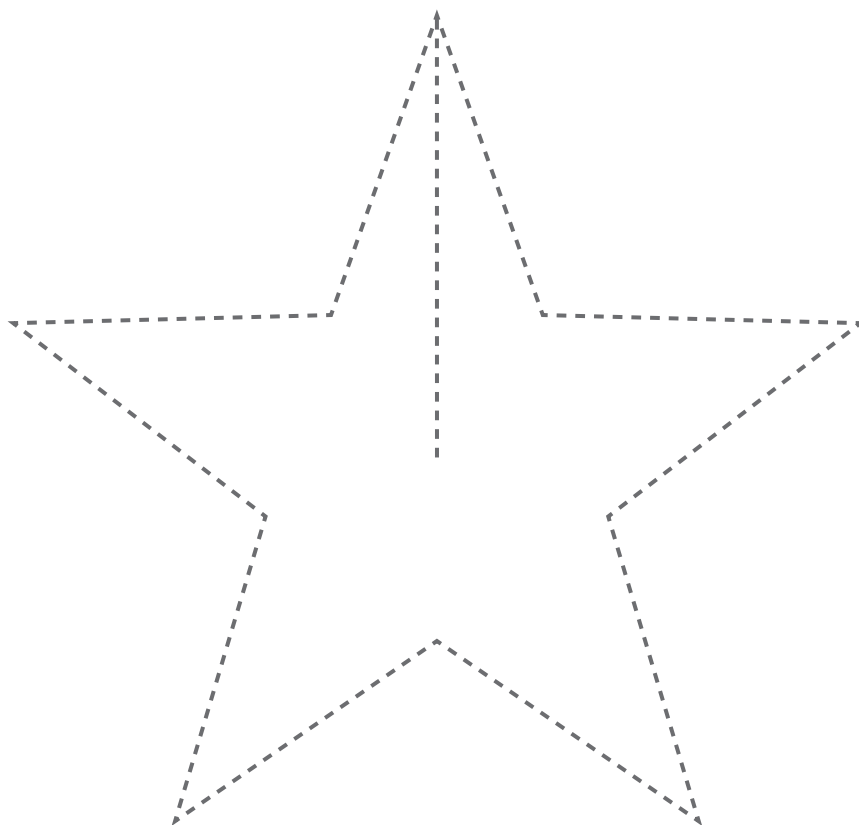



1 Make an egg and a chick.

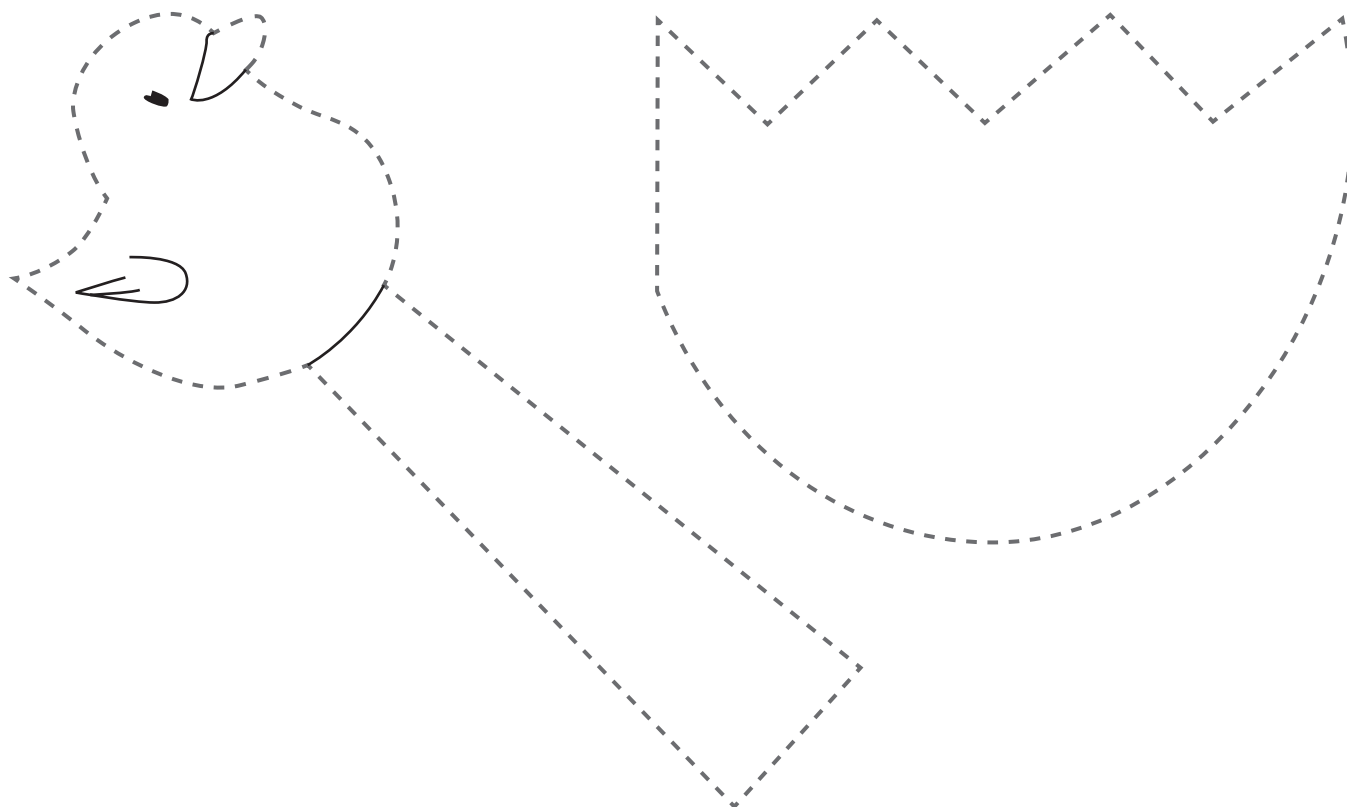
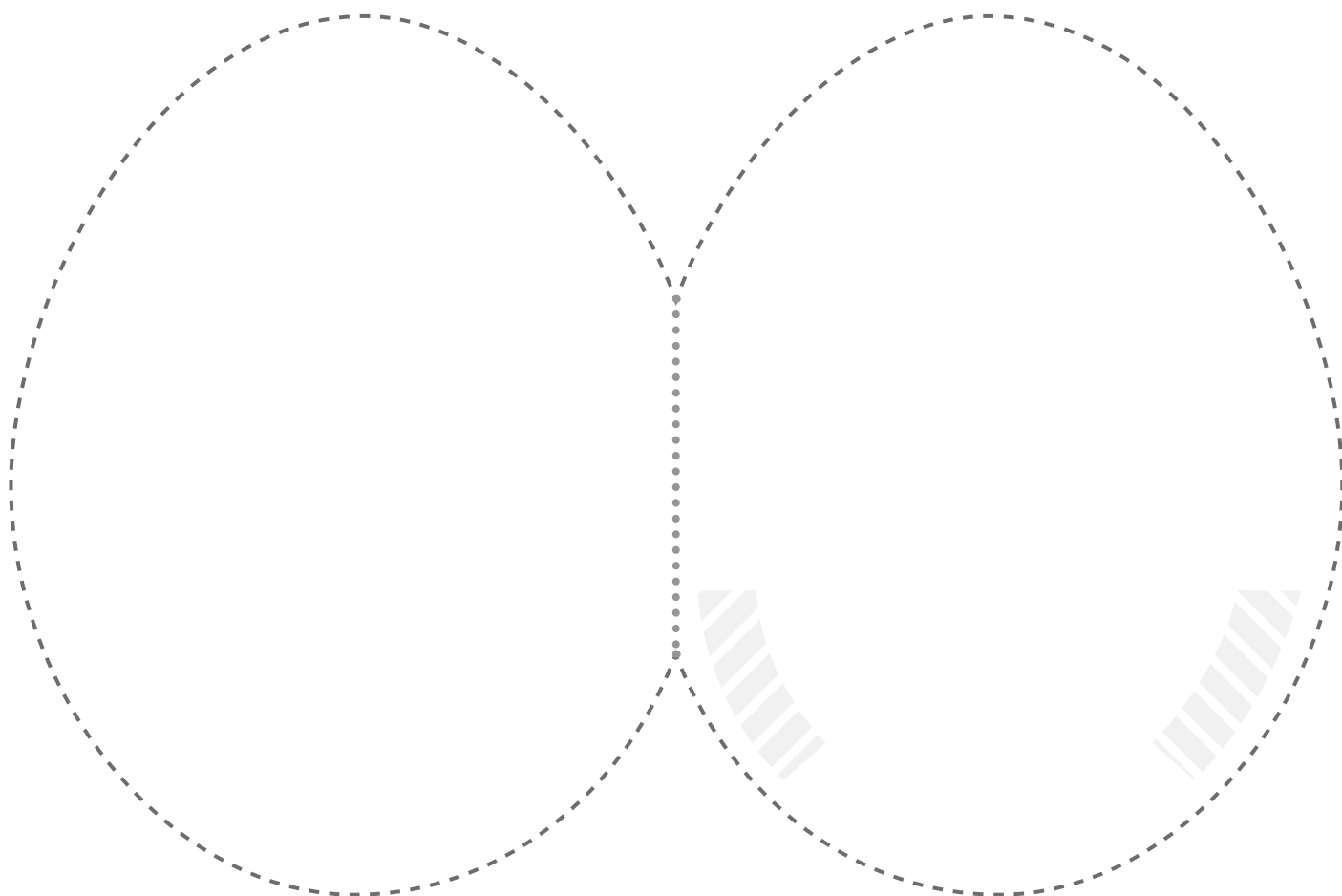

Teaching Notes

Unit 1 Reinforcement 1

1 Match and draw. Trace.

- 1 bike
- 2 doll
- 3 skateboard
- 4 scooter
- 5 ball
- 6 kite
- 7 skipping rope
- 8 book

Unit 1 Reinforcement 2

1 Look, read and tick ✓.

- 1 ball, big
- 2 doll, new
- 3 book, small
- 4 scooter, old

2 Trace. Look, read and number.

3 big, 4 small, 1 old, 2 new

Unit 2 Reinforcement 1

1 Follow and trace. Tick ✓ or cross X.

1 ✓ 2 X 3 X 4 ✓ 5 X 6 ✓ 7 X 8 ✓

Unit 2 Reinforcement 2

1 Look, read and tick ✓.

- 1 body, tail, nose, legs
- 2 body, legs
- 3 body, tail
- 4 body, tail, legs

2 Trace. Look and number.

body 3
legs 4
nose 2
tail 1

Unit 3 Reinforcement 1

1 Complete. Read and circle.

- 1 lorry
- 2 taxi
- 3 bus
- 4 car
- 5 helicopter
- 6 train
- 7 motorbike
- 8 plane

Unit 3 Reinforcement 2

1 What's next? Match and write.

- 1 walk
- 2 run
- 3 eat
- 4 shout

Unit 4 Reinforcement 1

1 Look and number.

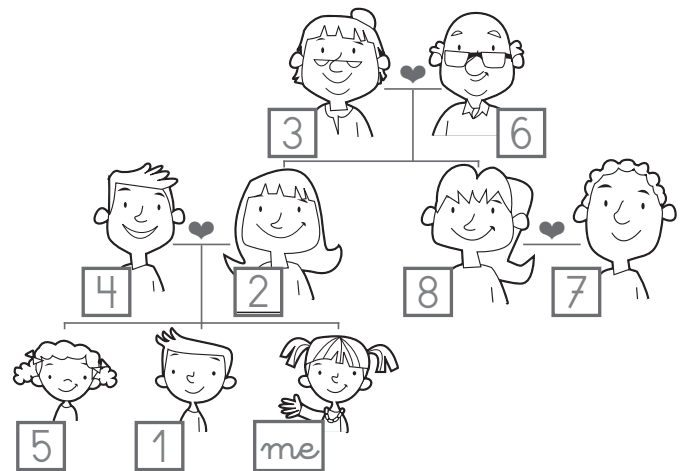

2 Write. Read and circle.

- 1 grandma
- 2 brother
- 3 grandpa
- 4 uncle
- 5 sister
- 6 dad
- 7 mum
- 8 aunty

Unit 4 Reinforcement 2

1 Match.

dance, sing, skip, jump

2 Complete and write.

- 1 He can *dance*.
- 2 She can *jump*.
- 3 She can *skip*.
- 4 He can *sing*.

Unit 5 Reinforcement 1

1 Circle and write

- 1 T-shirt
- 2 jacket
- 3 trousers
- 4 shoes
- 5 dress
- 6 cap
- 7 skirt
- 8 sunglasses

2 Look and write. Read and colour.

- 1 jacket
- 2 trousers
- 3 skirt
- 4 shoes

Unit 5 Reinforcement 2

1 Follow and draw.

- 1 hungry
- 2 tired
- 3 thirsty
- 4 sad
- 5 happy

2 Match and write.

- 1 happy
- 2 thirsty
- 3 tired
- 4 hungry
- 5 sad

Unit 6 Reinforcement 1

1 Join and trace. Count and write.

- 1 apples 6
- 2 cakes 5
- 3 sausages 8
- 4 tomatoes 8
- 5 eggs 4
- 6 olives 6
- 7 strawberries 12
- 8 sandwiches 10

Unit 6 Reinforcement 2

1 Read and colour. Look and write.

2 Draw 😊 or ☹️ for you.

- 1 cherries
- 2 apples
- 3 peaches
- 4 pears
- 5 oranges
- 6 olives
- 7 grapes
- 8 strawberries

Unit 1 Extension 1

1 Look, draw and write.

- 1 bike
- 2 ball
- 3 doll
- 4 scooter
- 5 skipping rope
- 6 skateboard
- 7 book
- 8 kite

Unit 1 Extension 2

1 Follow and write.

- 1 I've got a *book*. It's *small*.
- 2 I've got a *doll*. It's *old*.
- 3 I've got a *ball*. It's *big*.
- 4 I've got a *scooter*. It's *new*.

Unit 2 Extension 1

1 Complete and write.

- 1 It's a *horse*.
- 2 It's a *cat*.
- 3 It's a *rabbit*.
- 4 It's a *dog*.
- 5 It's a *mouse*.
- 6 It's a *bird*.
- 7 It's a *frog*.
- 8 It's a *fish*.

Unit 2 Extension 2

1 Match and write. Read and colour.

- 1 dog
- 2 horse
- 3 fish
- 4 frog

Unit 3 Extension 1

1 Look and write.

- 1 bus
- 2 helicopter
- 3 train
- 4 plane
- 5 motorbike
- 6 lorry
- 7 taxi
- 8 car

2 Look, colour and write.

- 1 I can see a *bus*. It's *red*.
- 2 I can see a *motorbike*. It's *orange*.
- 3 I can see a *plane*. It's *blue*.
- 4 I can see a *train*. It's *green*.

Unit 3 Extension 2

1 Read and match.

- 1 Tom
- 2 Pam
- 3 Pat
- 4 Emma

2 Write, match and number.

- Don't eat! 3
 Don't run! 2
 Don't shout! 4
 Walk! 1
 Eat! 5

Unit 4 Extension 1

1 Look and write.

- 1 grandma
- 2 grandpa
- 3 dad
- 4 mum
- 5 aunty
- 6 uncle
- 7 my sister
- 8 This is my brother.

Unit 4 Extension 2

1 Look and write.

- 1 This is my *grandpa*. He can *dance*.
- 2 This is my *sister*. She can *skip*.
- 3 *This is my brother*. He can *jump*.
- 4 *This is my mum*. She can *sing*.

2 Draw and write about your friend.

(Children's own answers)

Unit 5 Extension 1

1 Write.

- 1 skirt
- 2 trousers
- 3 jacket
- 4 cap
- 5 dress
- 6 T-shirt
- 7 sunglasses
- 8 shoes

2 Look and write. Draw and write for you.

I'm wearing a *dress* and *shoes*.

I'm wearing a *T-shirt* and *shorts*.

Unit 5 Extension 2

1 Write and match.

- 1 She's sad.
- 2 She's tired.
- 3 She's hungry.
- 4 He's hungry.
- 5 She's happy.
- 6 He's tired.
- 7 He's thirsty.
- 8 She's thirsty.

Unit 6 Extension 1

1 Look, circle and write.

- 1 I like *sausages*.
- 2 I like *tomatoes*.
- 3 I don't like *olives*.
- 4 I don't like *cakes*.
- 5 I like *sandwiches*.
- 6 I don't like *apples*.
- 7 I don't like *eggs*.
- 8 I like *strawberries*.

2 Count and colour.

- sausages - brown
- tomatoes - red
- olives - green
- cakes - brown
- sandwiches - yellow
- apples - green
- eggs - yellow
- strawberries - red

Unit 6 Extension 2

1 Follow and write.

2 Follow, draw and write for you.

- 1 I like *cakes*.
- 2 I don't like *grapes*.
- 3 I don't like *peaches*.
- 4 I like *oranges*.
- 5 olives
- 6 cherries

Halloween Reinforcement

1 Match and trace.

- 1 rat
- 2 witch
- 3 monster
- 4 bat
- 5 pumpkin
- 6 ghost

Christmas Reinforcement

1 Trace, count and write.

- 1 carrot 3
- 2 mince pie 4
- 3 present 6
- 4 star 8
- 5 stocking 2
- 6 tree 1

Easter Reinforcement

1 Look, trace and number.

- Hot cross buns 5
- basket 1
- Easter eggs 2
- Chick 4
- Easter bunny 6
- Flowers 3

Halloween Extension

1 Look, number and write.

- I'm a *witch*. 4
- I'm a *rat*. 3
- I'm a *ghost*. 1
- I'm a *bat*. 6
- I'm a *pumpkin*. 5
- I'm a *monster*. 2

Christmas Extension

1 Colour the key 2 Look, colour and write

- 1 It's a *present*.
- 2 It's a *star*.
- 3 It's a *Christmas tree*.
- 4 It's a *stocking*.
- 5 It's a *mince pie*.
- 6 It's a *carrot*.

Easter Extension

1 Look and write.

- 1 basket
- 2 Easter eggs
- 3 flowers
- 4 chick
- 5 Hot Cross Buns
- 6 Easter Bunny

2 Look again, count and write.

- 1 I can see 1 basket.
- 2 I can see 3 Easter eggs.
- 3 I can see 3 flowers.
- 4 I can see 2 chicks.
- 5 I can see 3 Hot Cross Buns.
- 6 I can see 1 Easter bunny.