

2

1

3

5

4

3

3

3

3

3

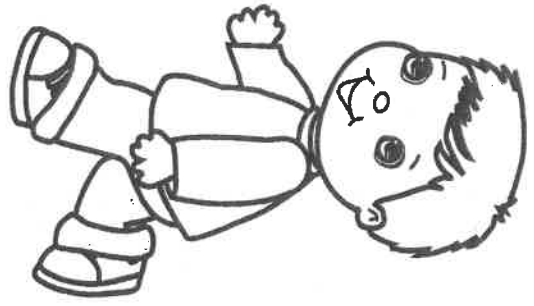
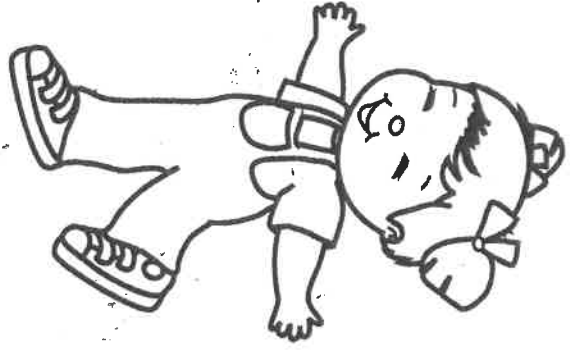
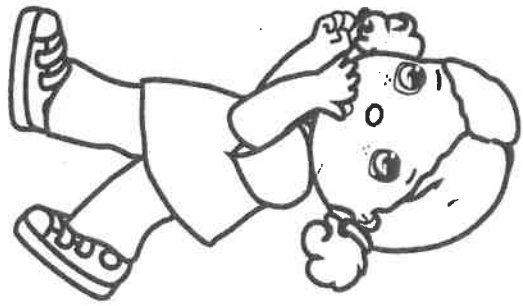
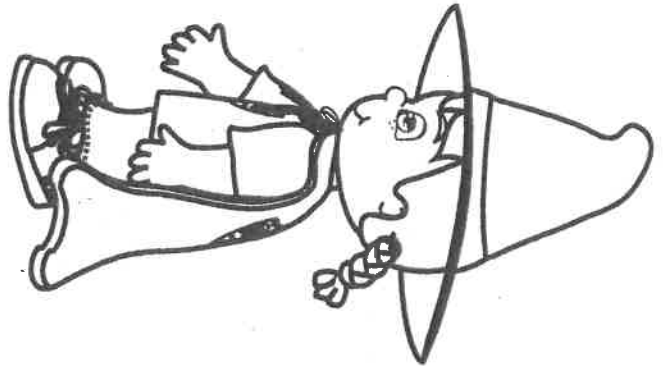

MY CITY

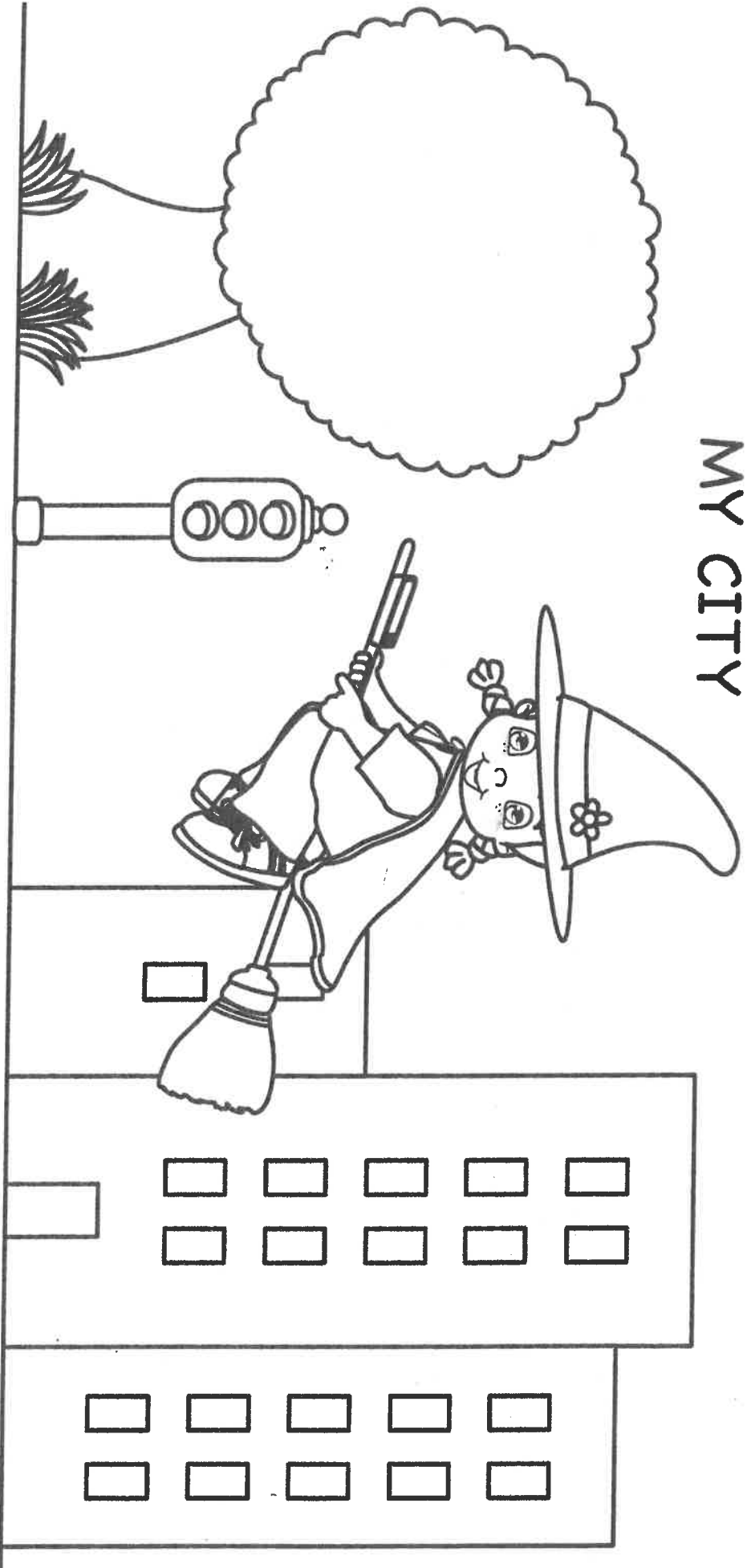

IT'S COLD

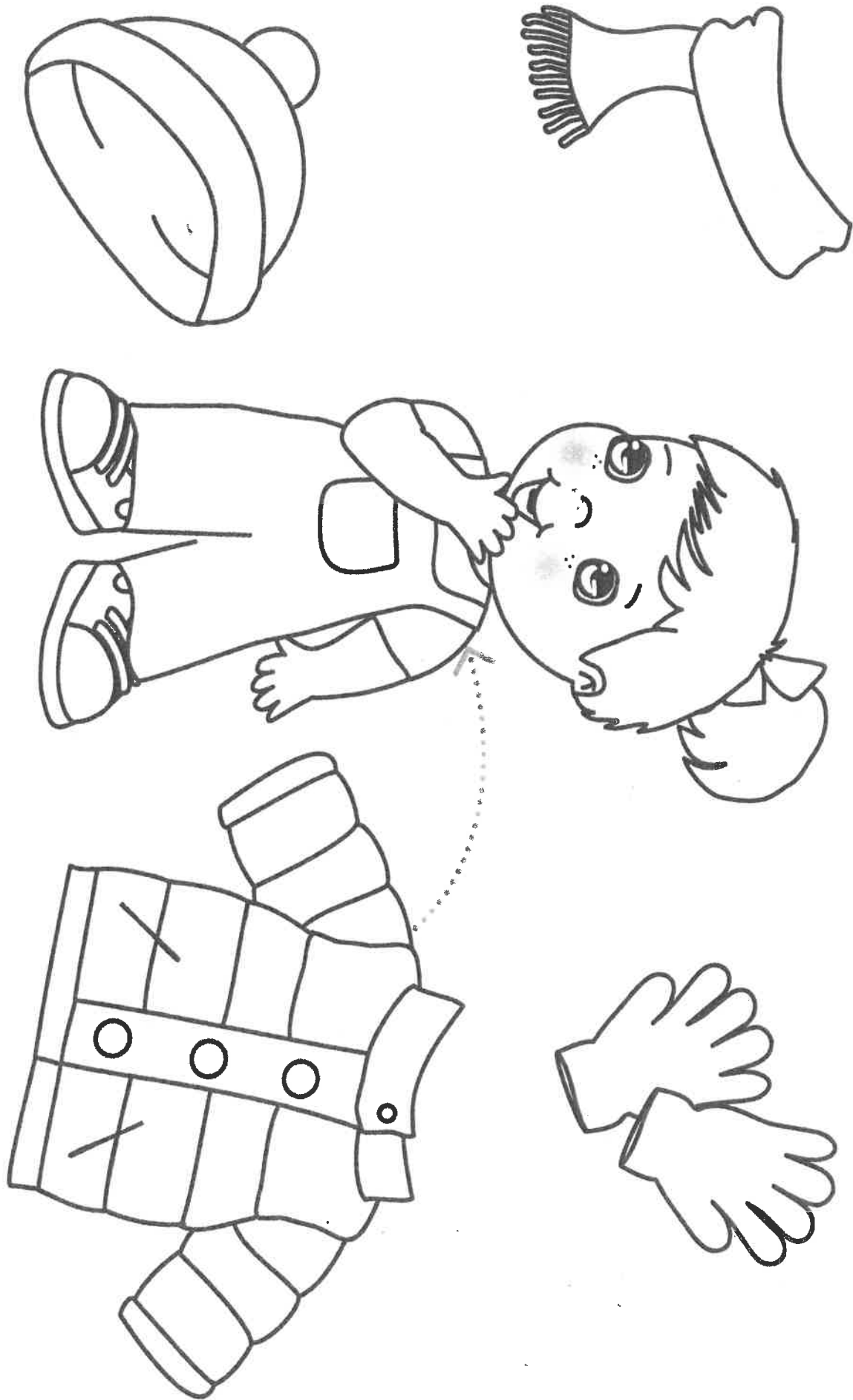

TRAVELLING AROUND THE WORLD



CAR

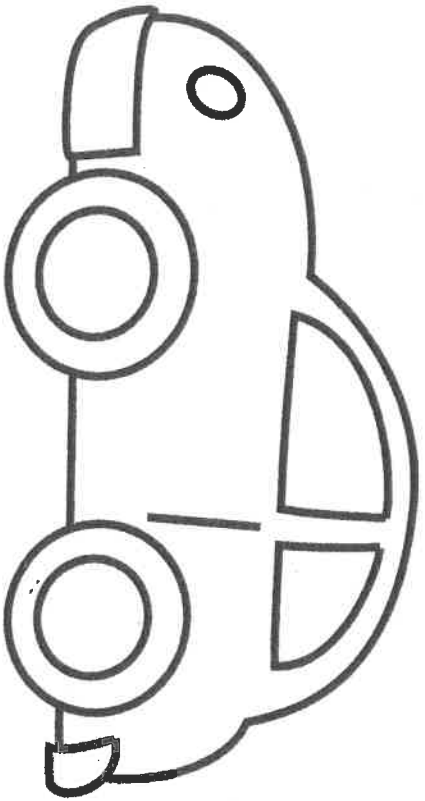

PLANE

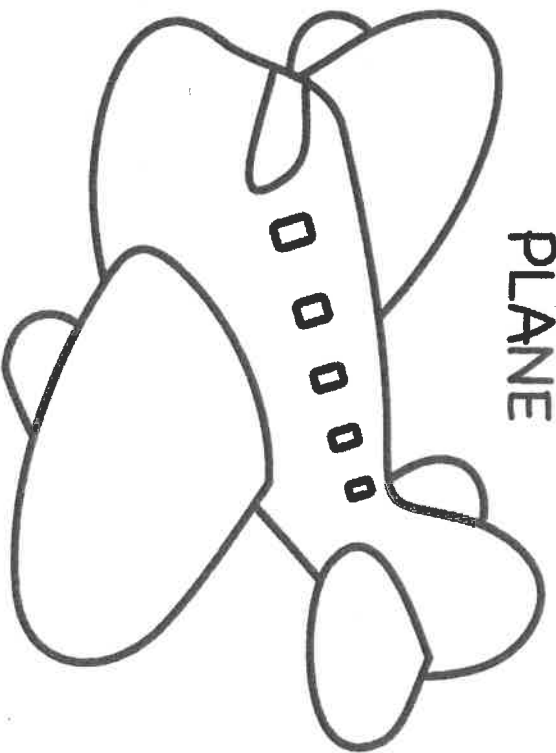

SHIP

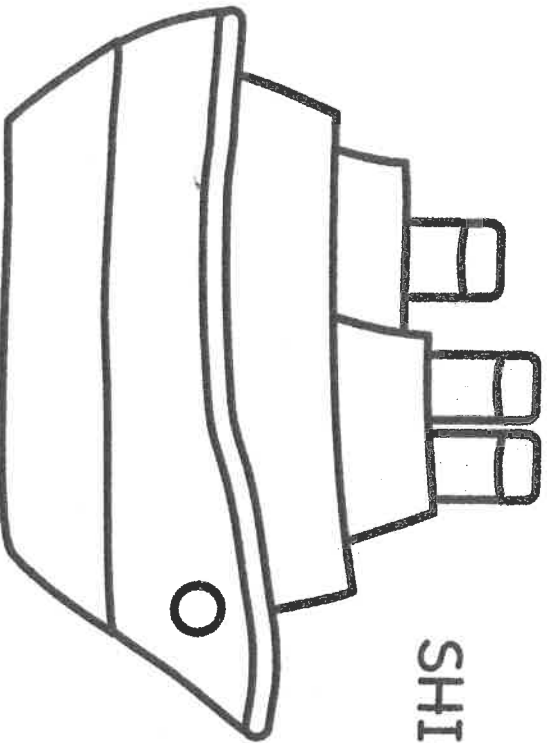

TRAIN

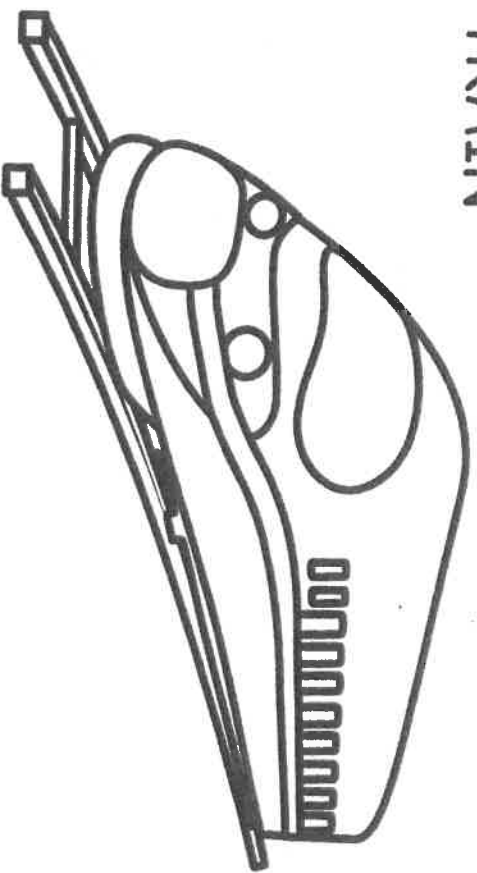

i I

Soy la iguana Isabelita
y en mi nombre está la "i".
Es un uno o un palito
y a veces tiene un puntito.



i i i i i i i i i i



Imma

Indio



uu

Soy el urogallo Ubaldo,
un pájaro muy bonito.
En mi nombre está la "u"
que tiene dos cuernecitos.

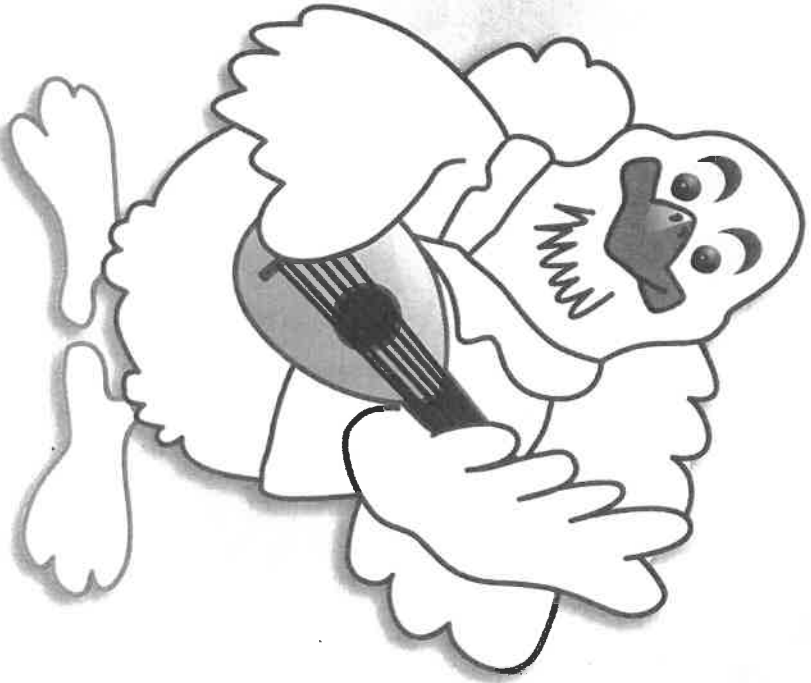

u u u u u u u u u u u u u u u u



Ubaldo

ukelele

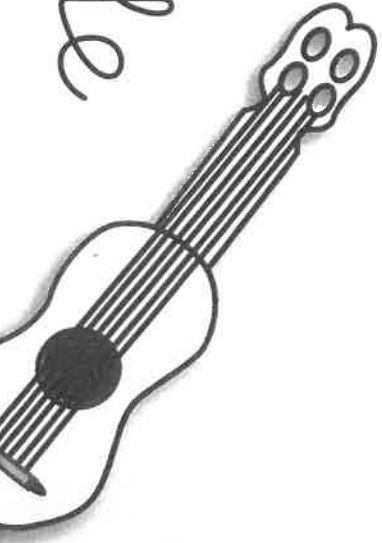

A A

Soy Alicia, una araña,
y en mi nombre está la "a".
Con redondel o palotes
tú la puedes dibujar.

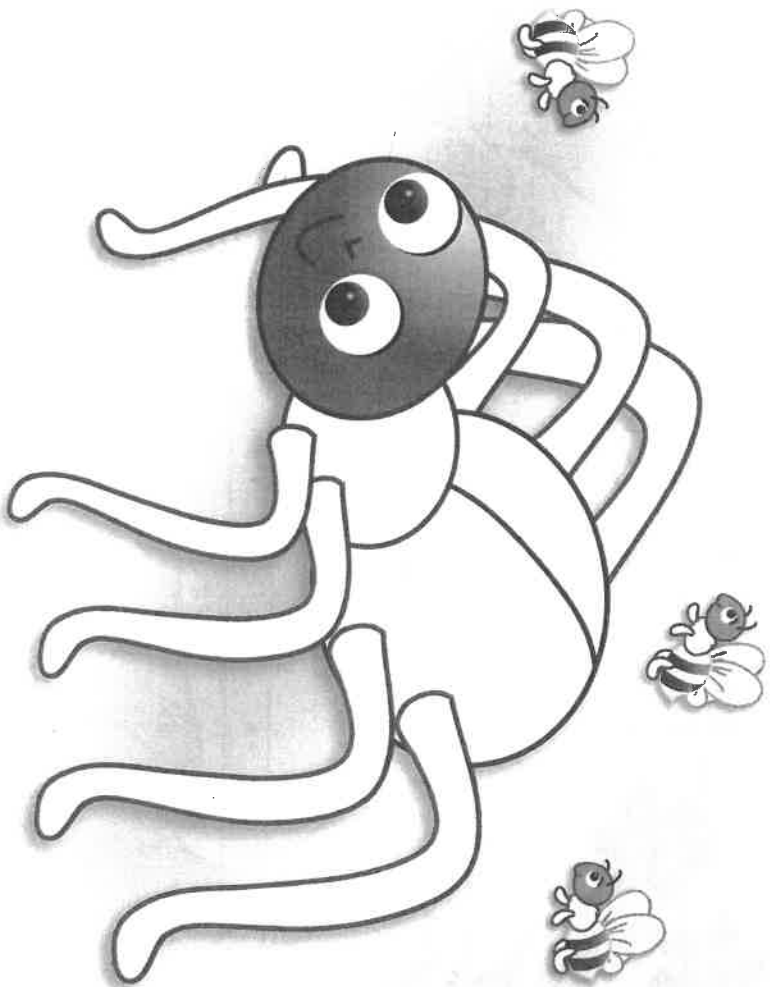

A A A A A A A A A A



A A A A A A A A A A

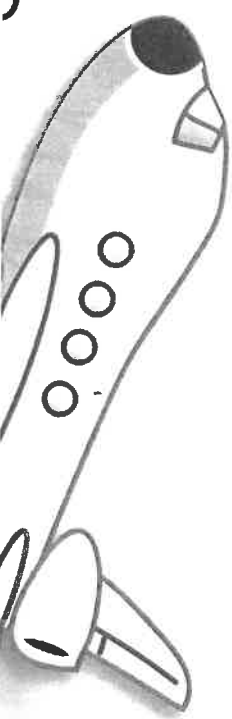

e

E

Soy el erizo Elmo,
pincho y pincho sin parar.
En mi nombre está la "e"
que es muy fácil dibujar.



e E e E e E e E e E

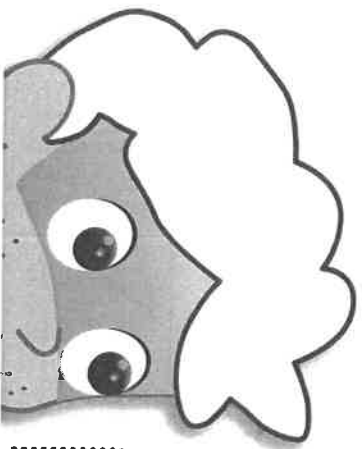

E milis e segundos,

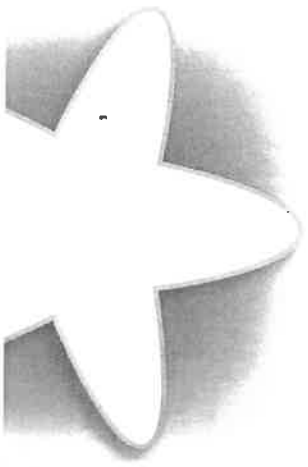

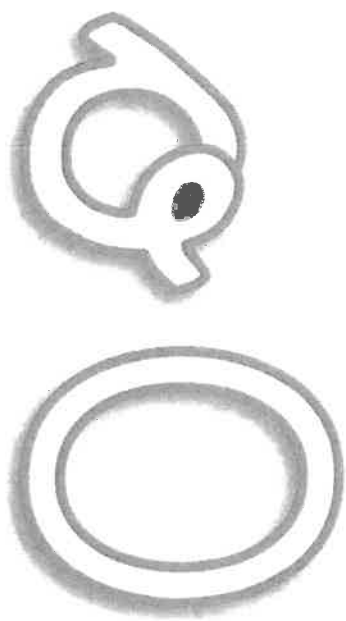

Soy el oso Osvaldo
y en mi nombre está la "o".
Para escribir esta letra
sin rayos dibuja un sol.

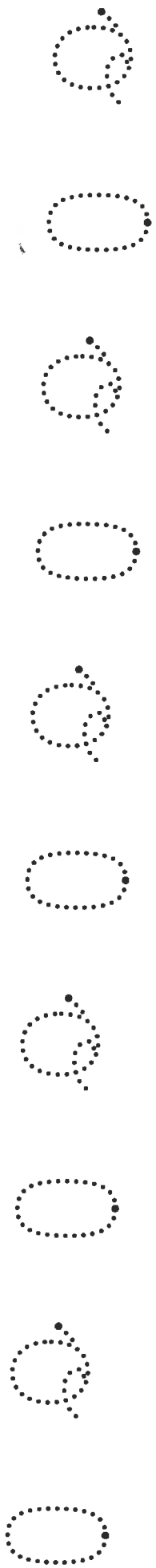

Óscar

oso



Pingu

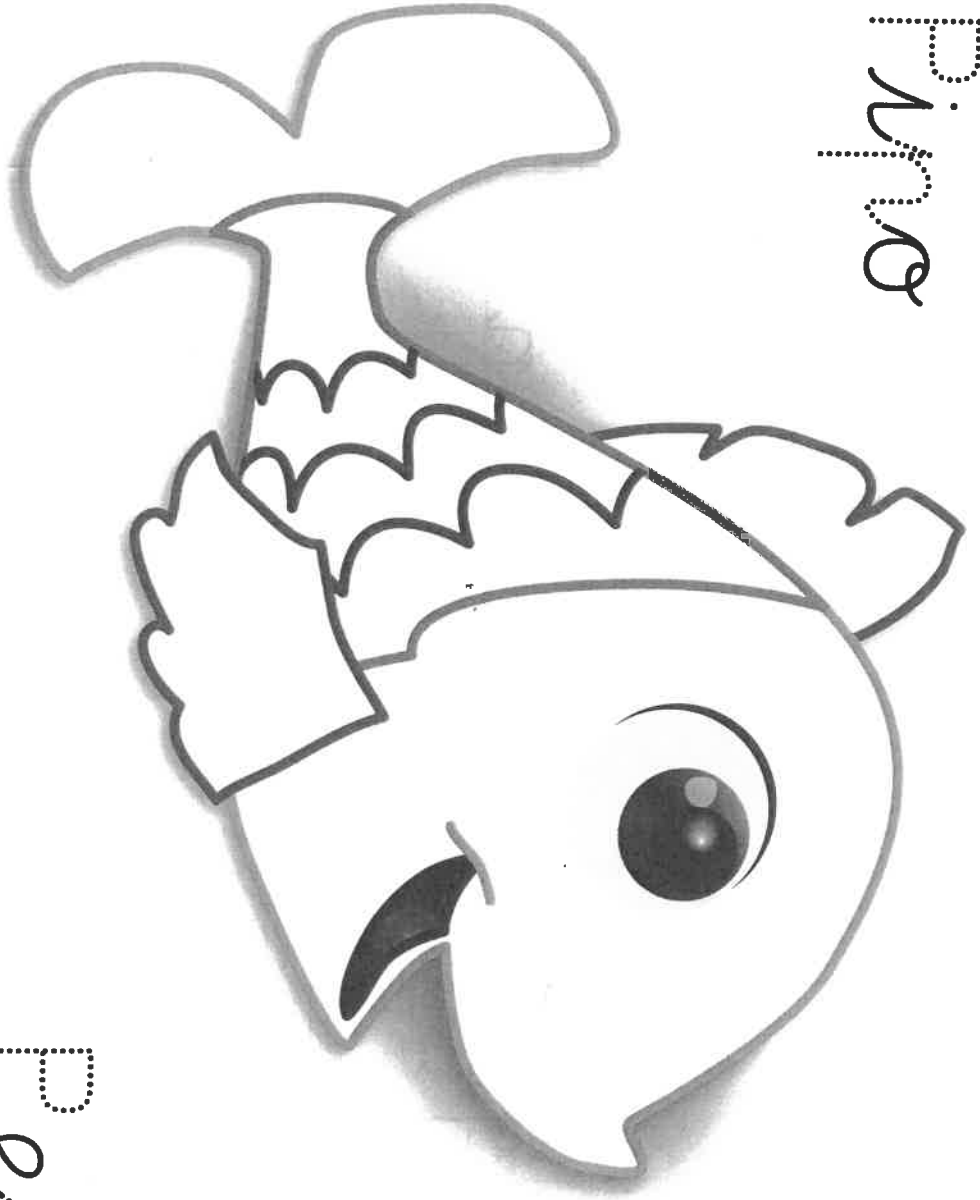

Perna

