

Trabajamos
la grafía
de las letras

Nombre del alumno.....Curso.....

Nombre _____

Fecha _____

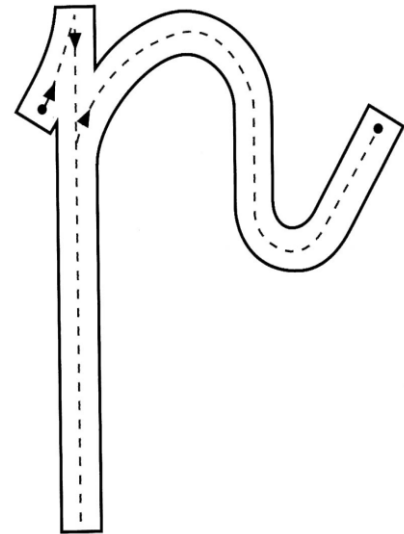
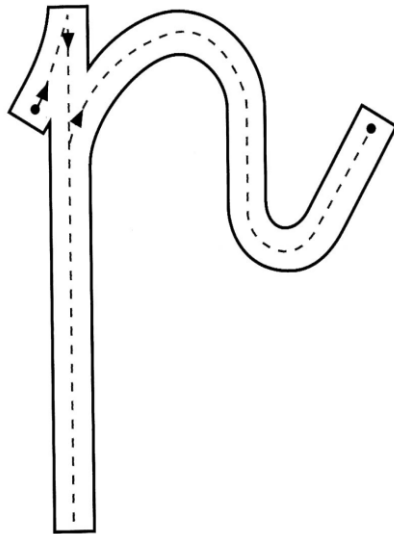
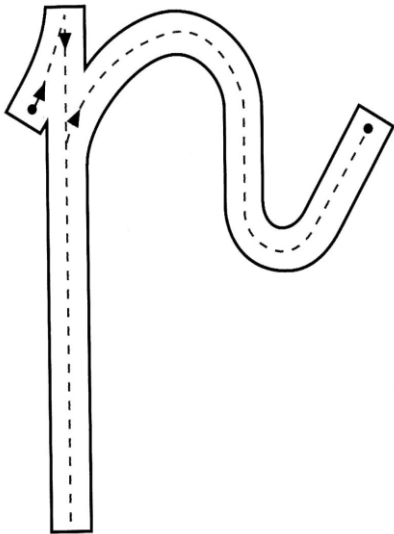
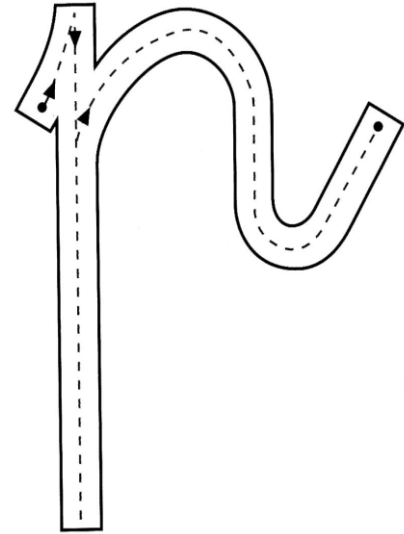
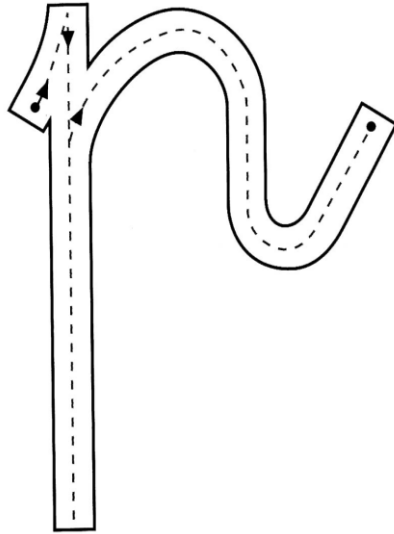
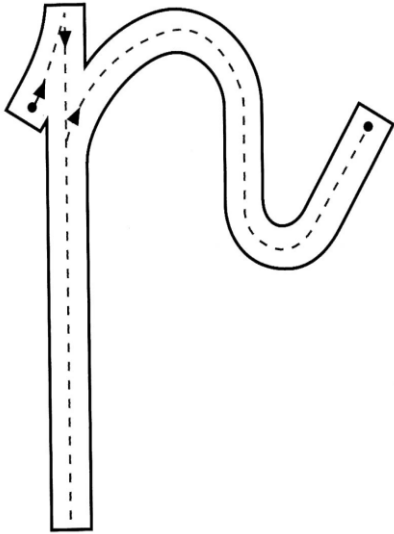

Nombre _____

Fecha _____

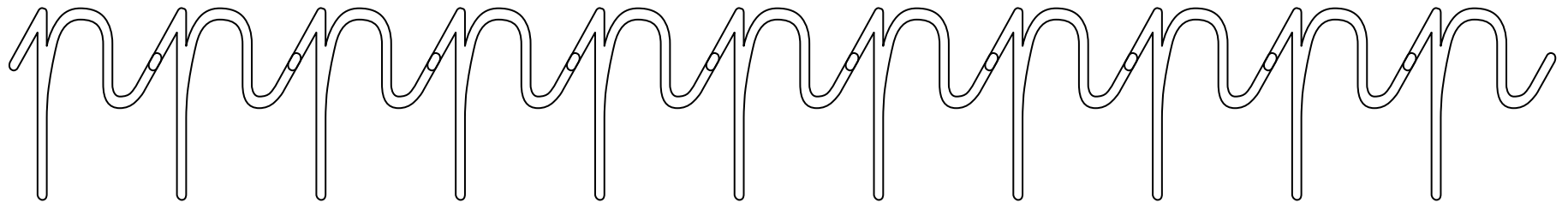
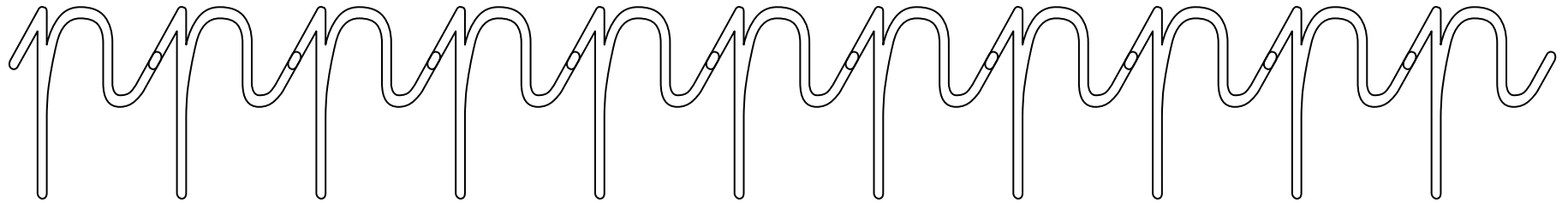
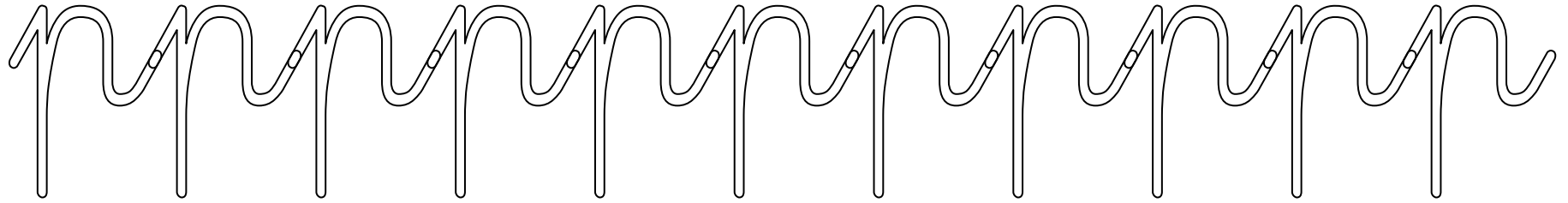

Nombre _____

Fecha _____

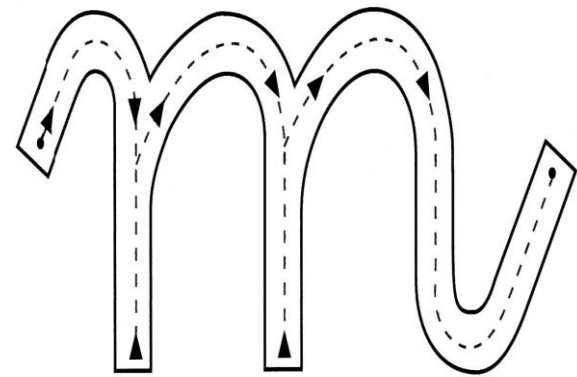
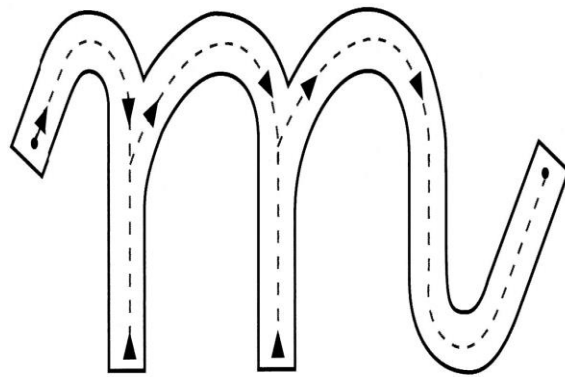
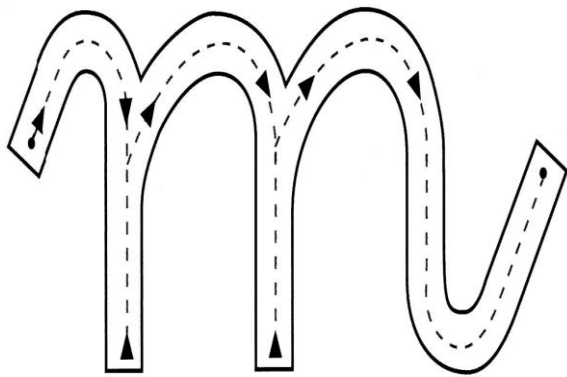
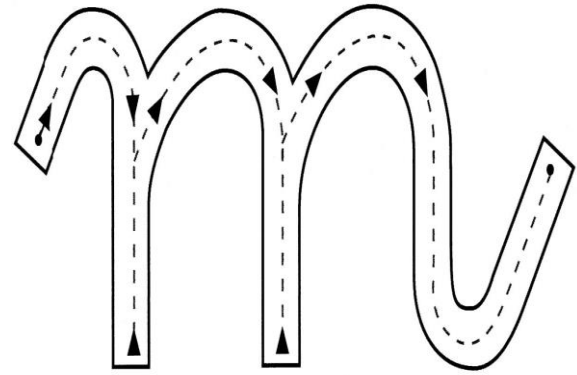
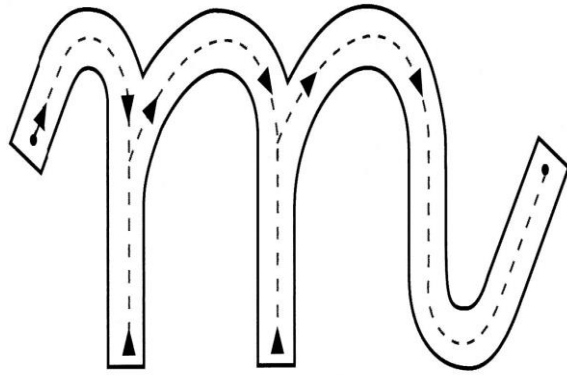
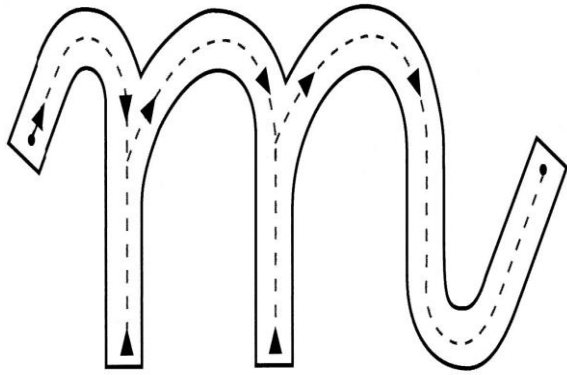

Nombre _____

Fecha _____

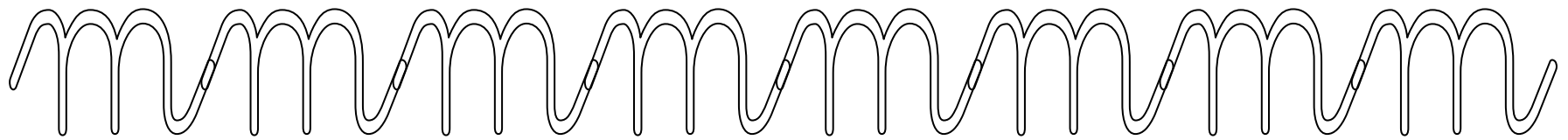
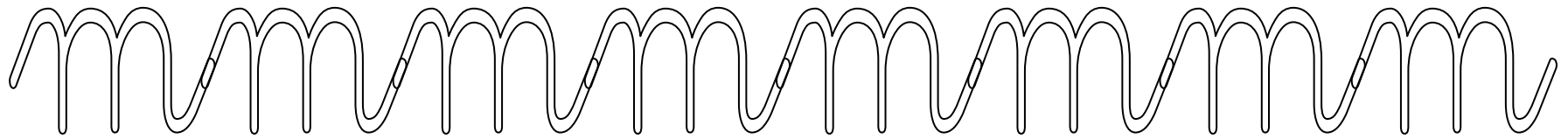
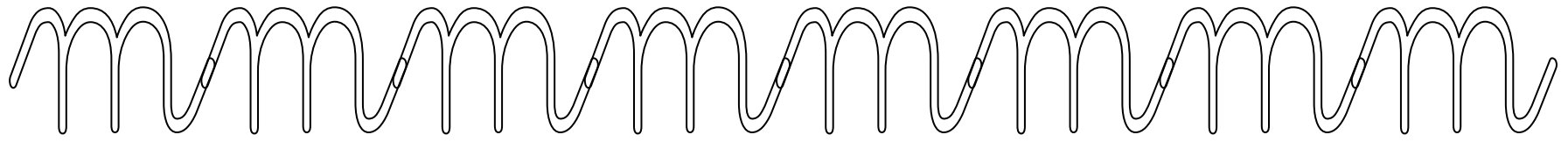

Nombre _____

Fecha _____

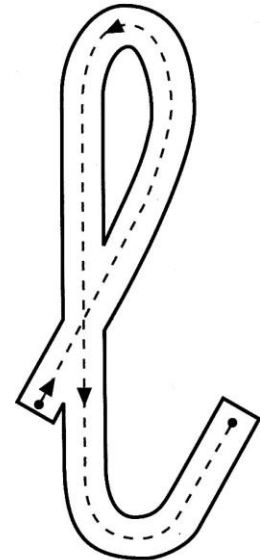
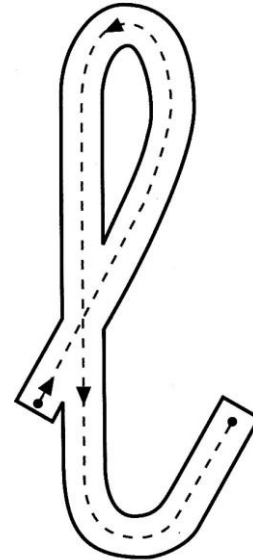
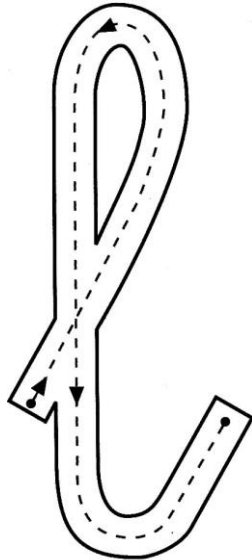
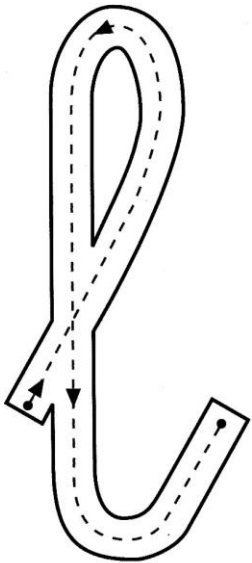
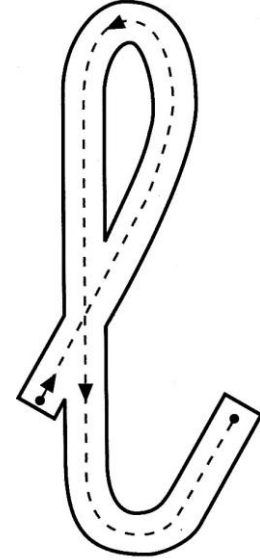
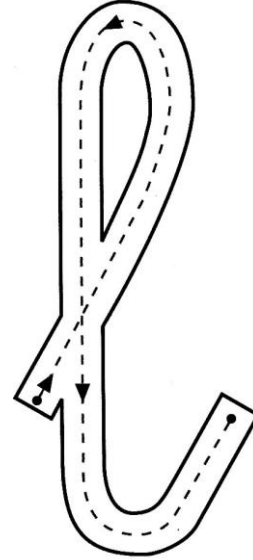
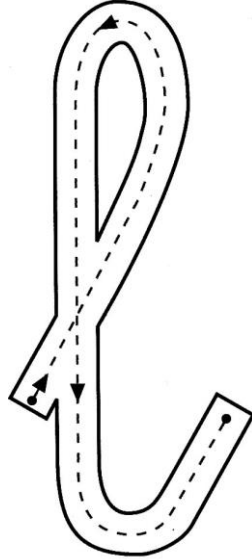
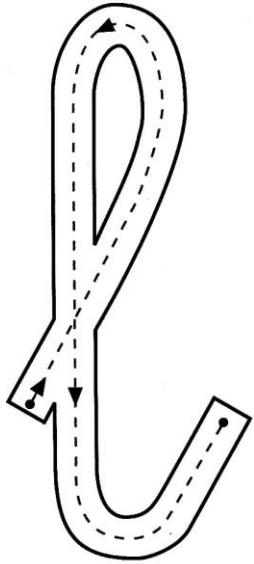

Nombre _____

Fecha _____

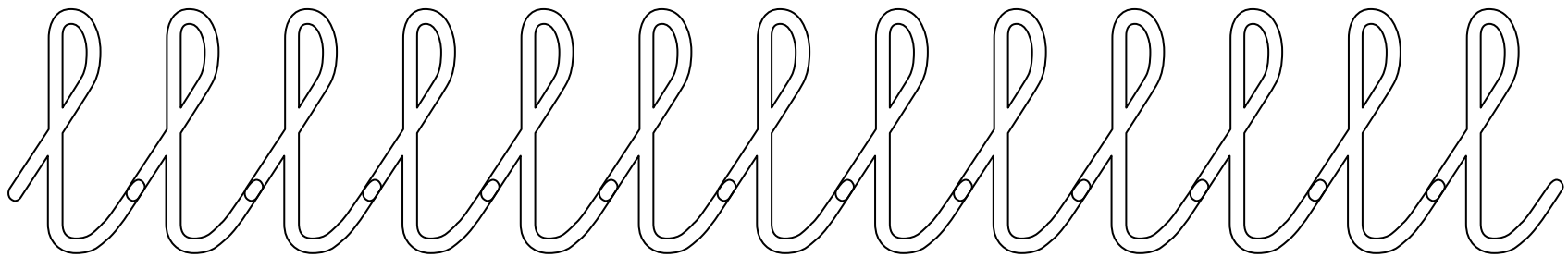
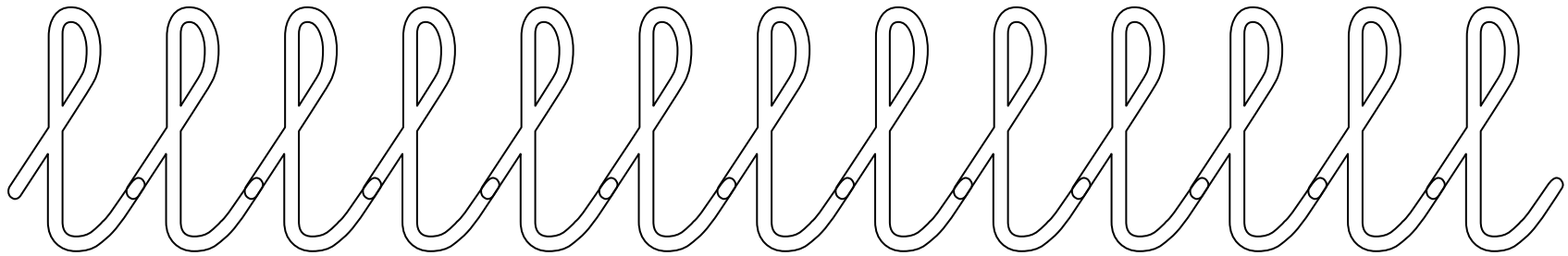
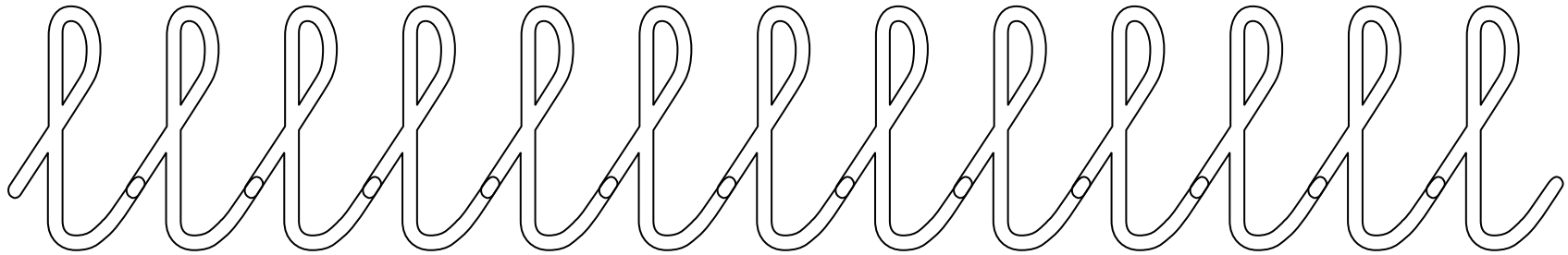

Nombre _____

Fecha _____

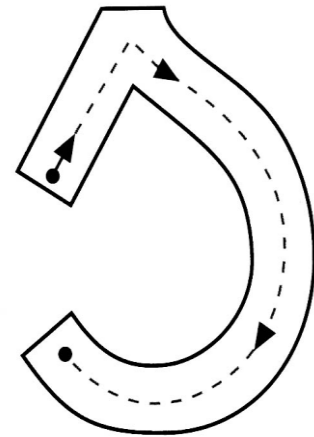
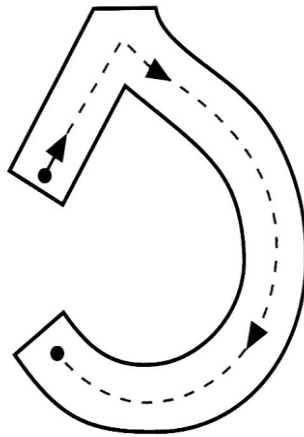
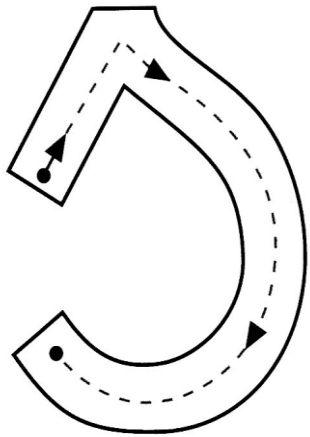
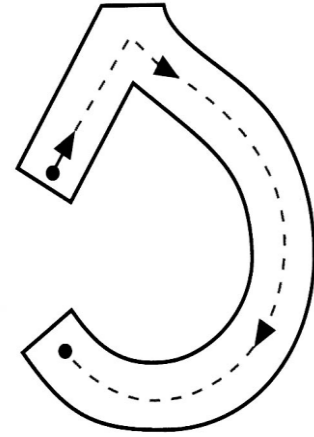
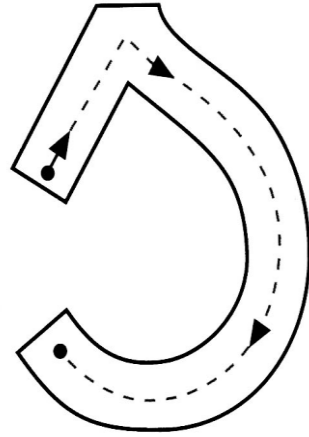
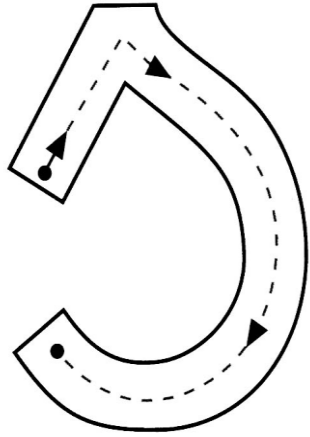

Nombre _____

Fecha _____

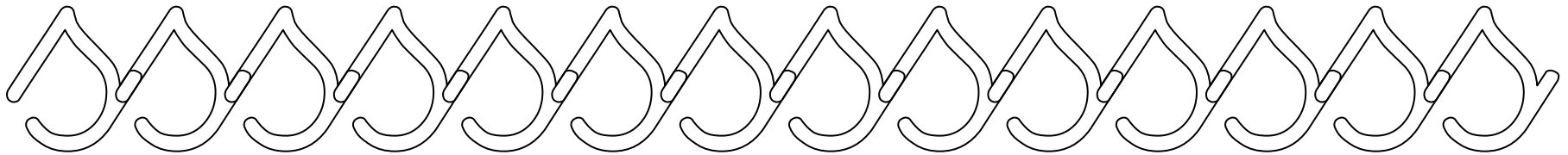
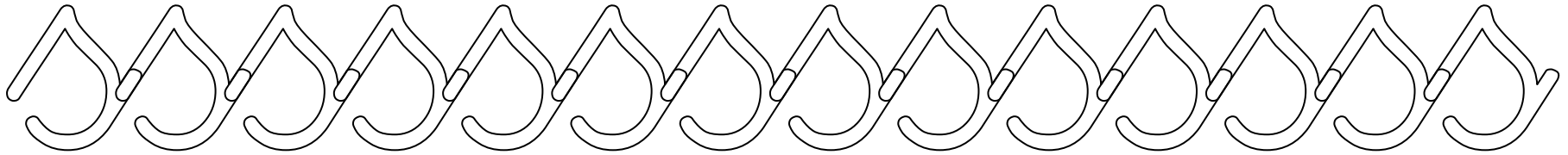
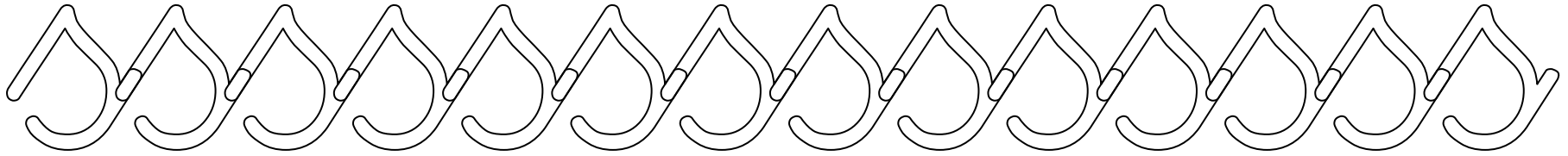

Nombre _____

Fecha _____

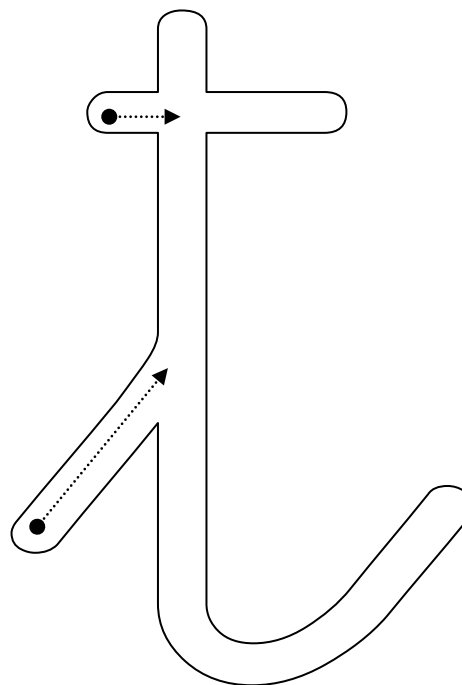
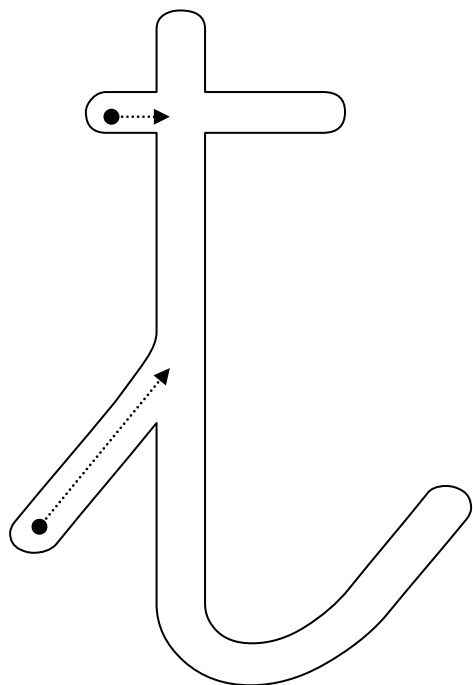

Nombre _____

Fecha _____

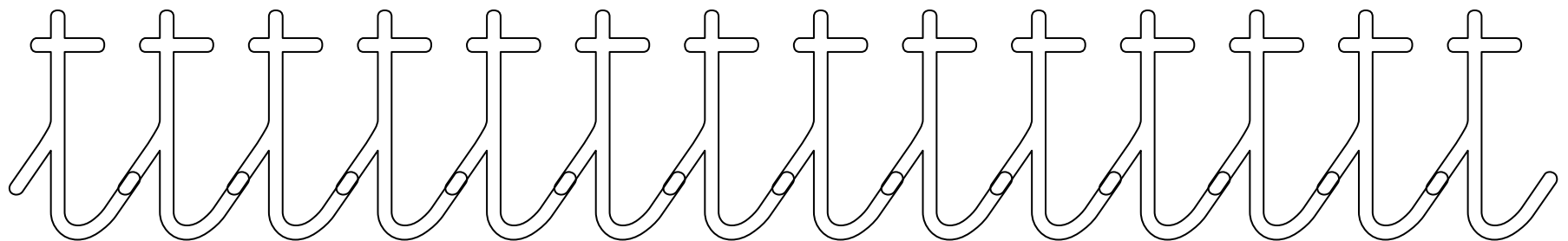
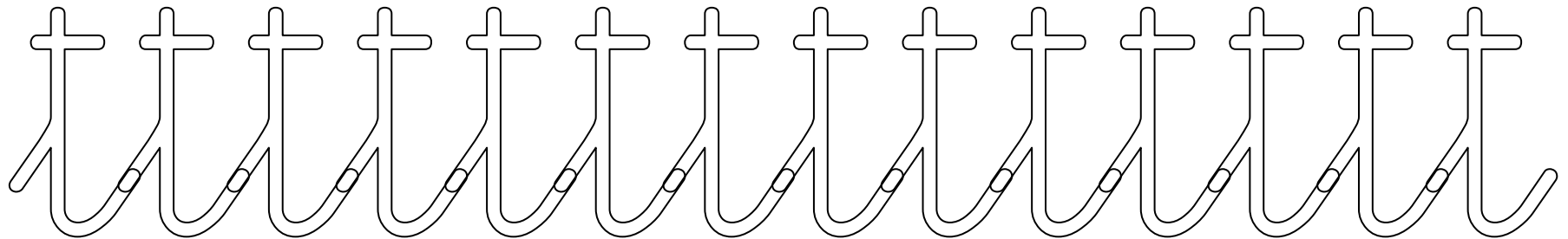
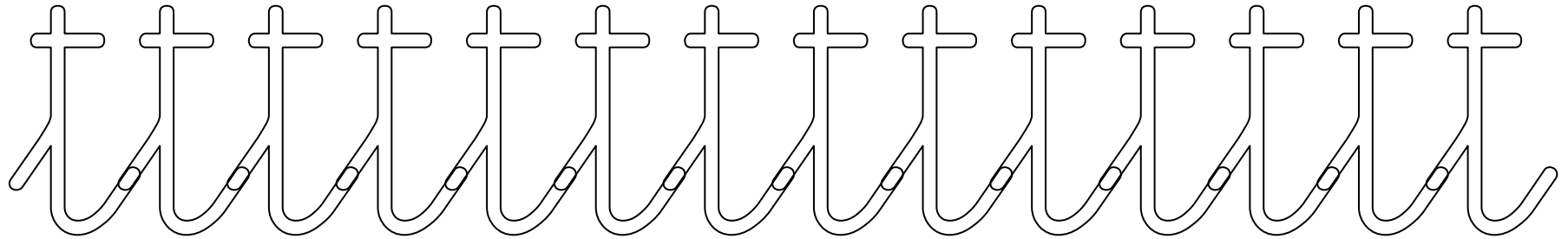

Nombre _____

Fecha _____

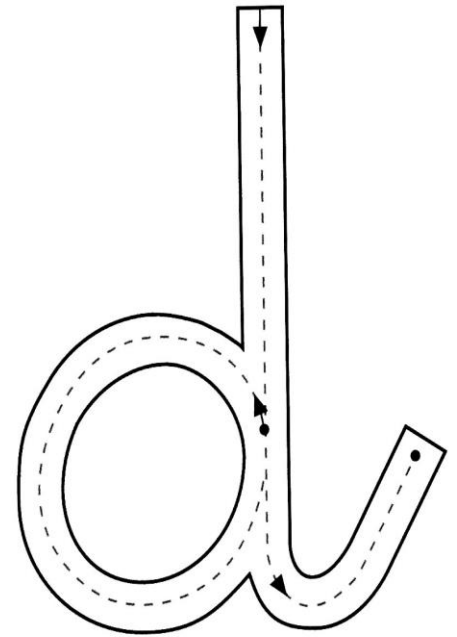
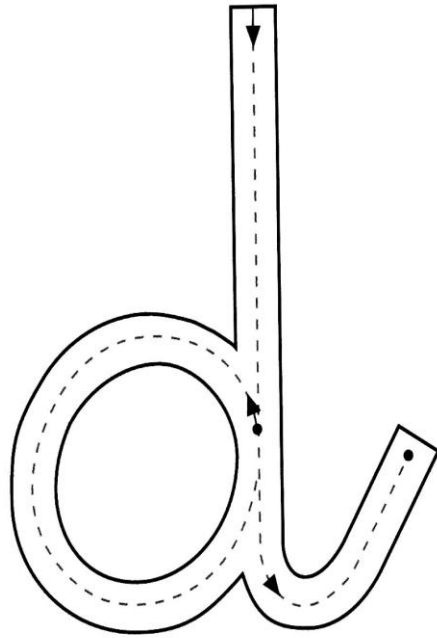
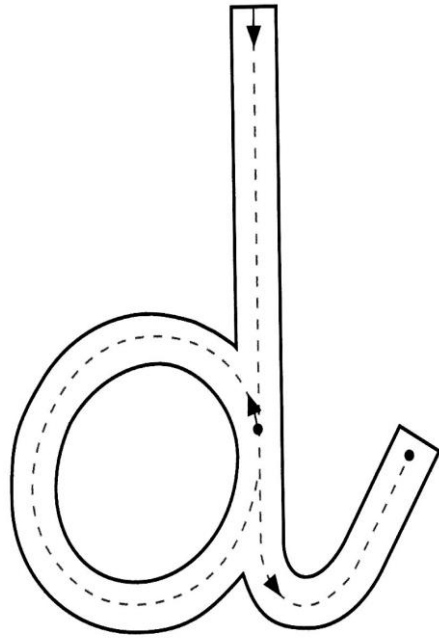

Nombre _____

Fecha _____

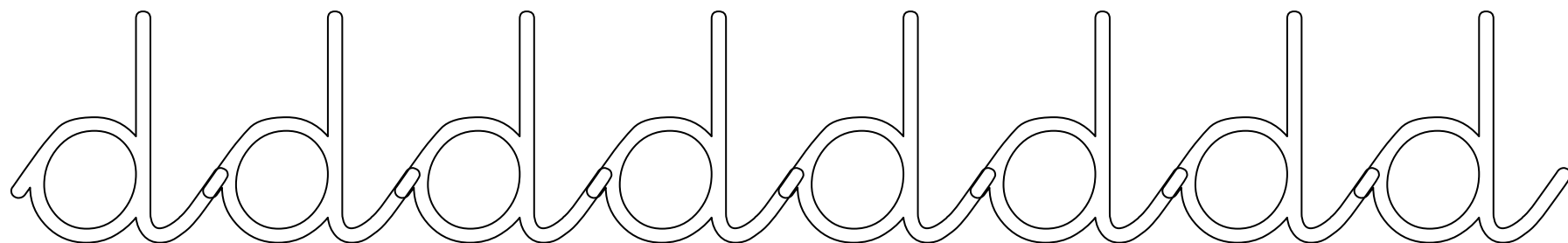
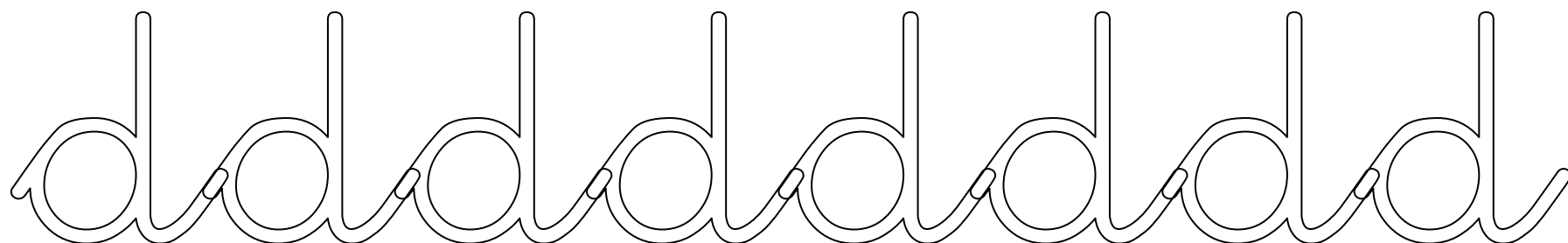
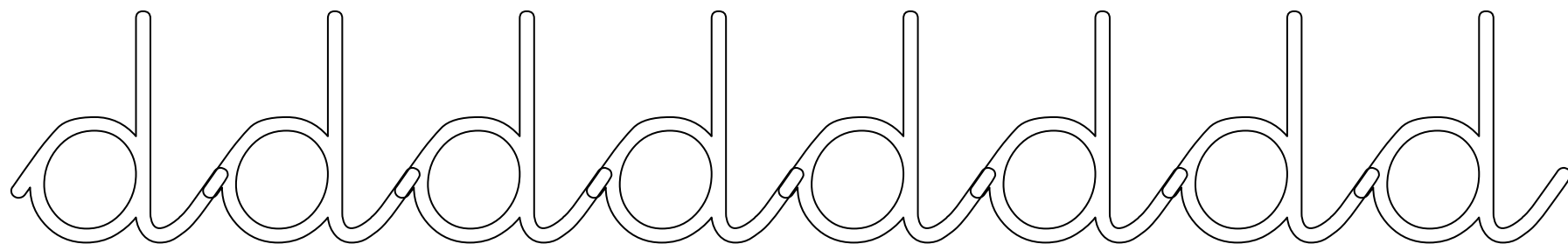

Nombre _____

Fecha _____

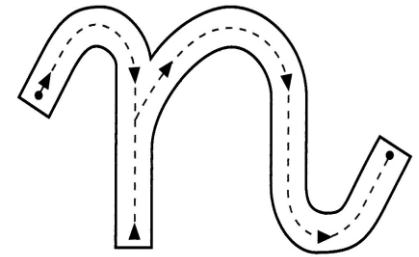
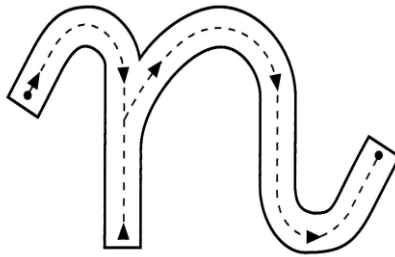
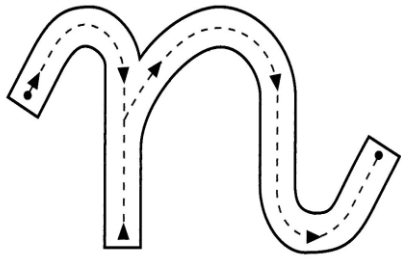
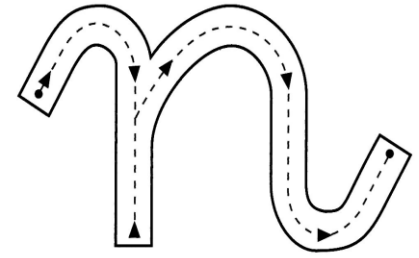
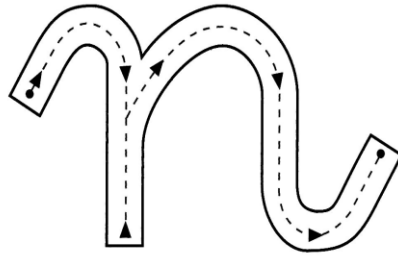
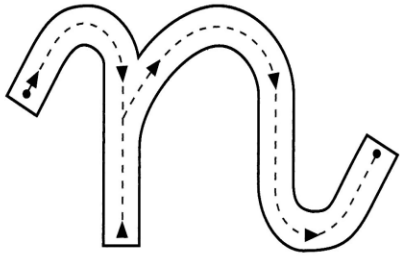

Nombre _____

Fecha _____

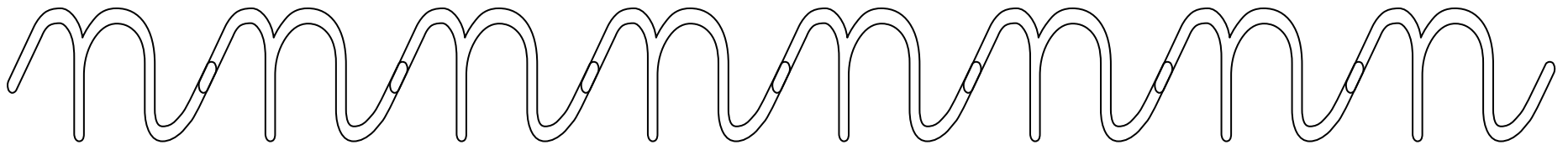
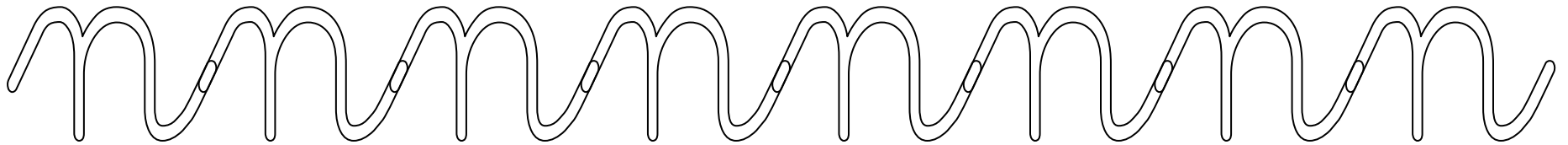
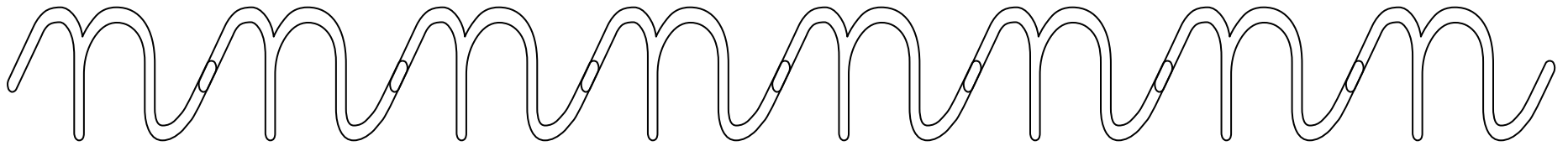

Nombre _____

Fecha _____

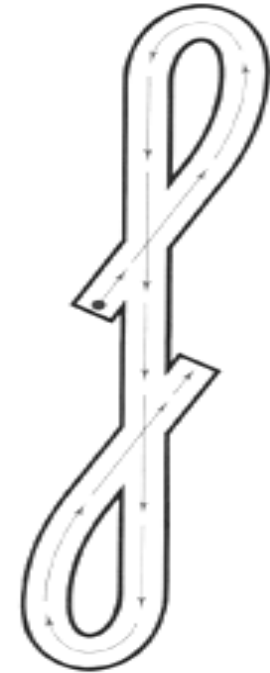
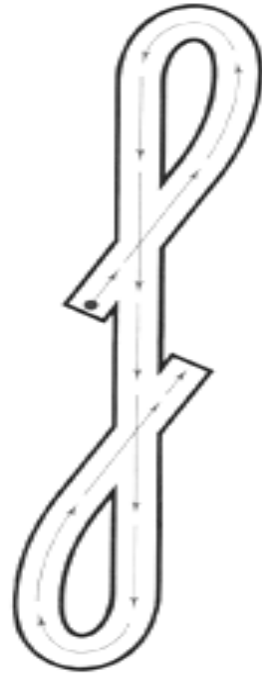
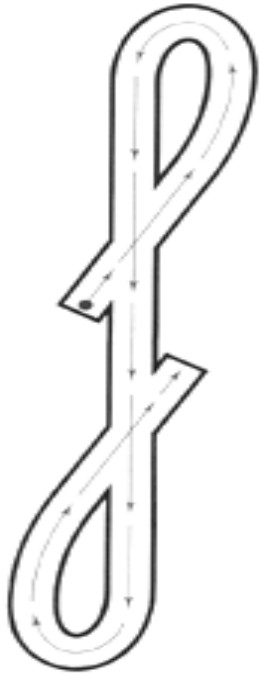

Nombre _____

Fecha _____

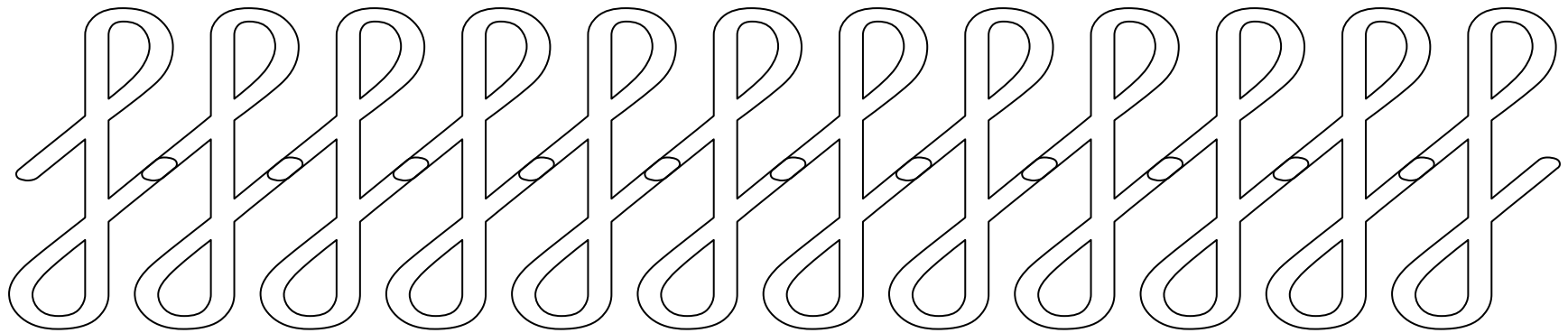
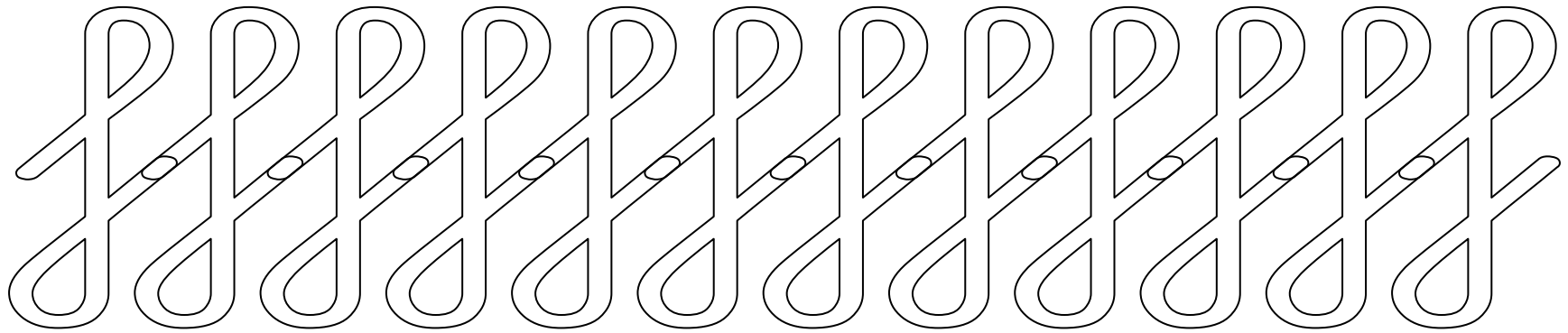
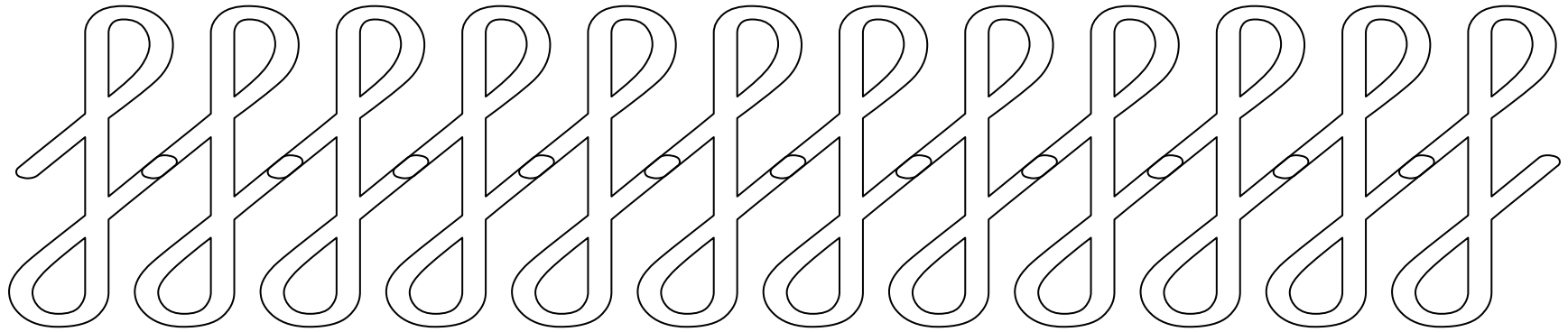

Nombre _____

Fecha _____

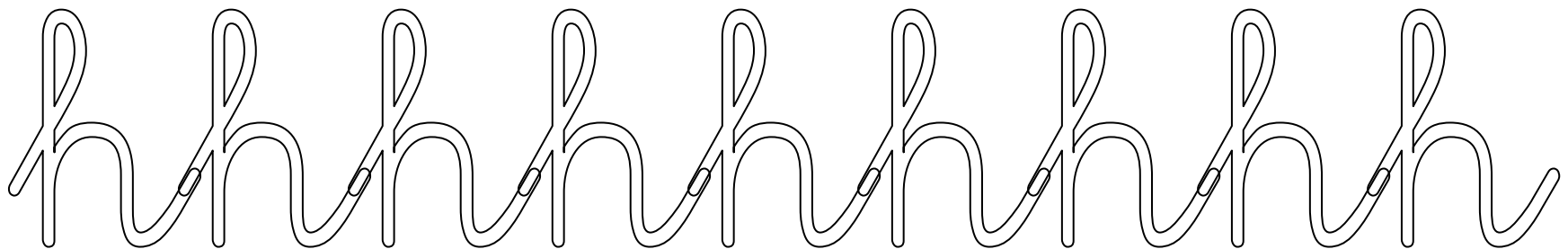
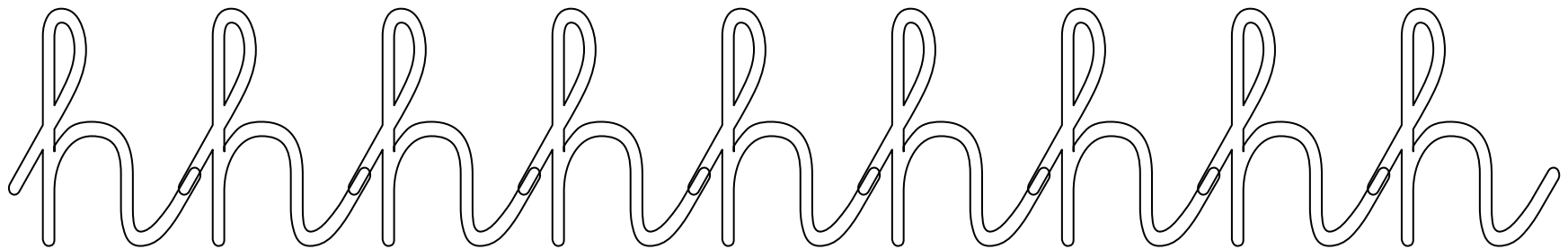
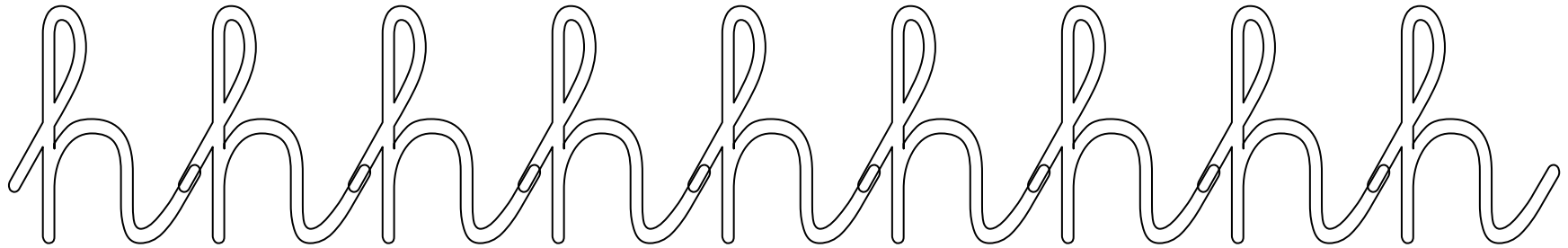

Nombre _____

Fecha _____

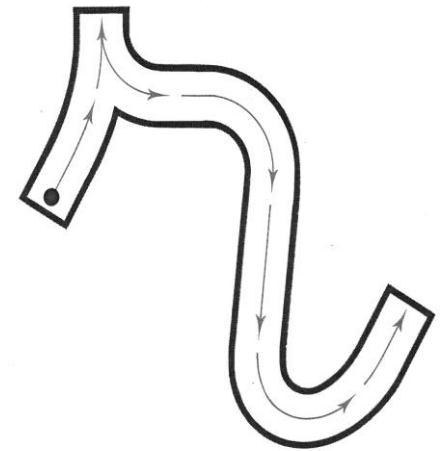
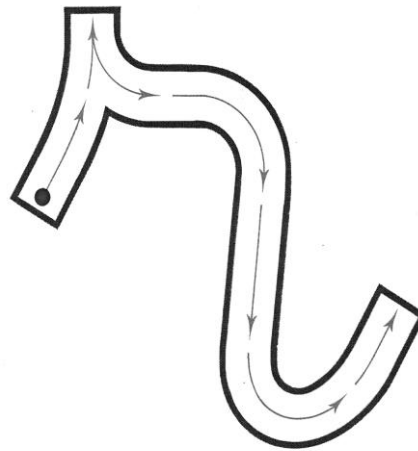
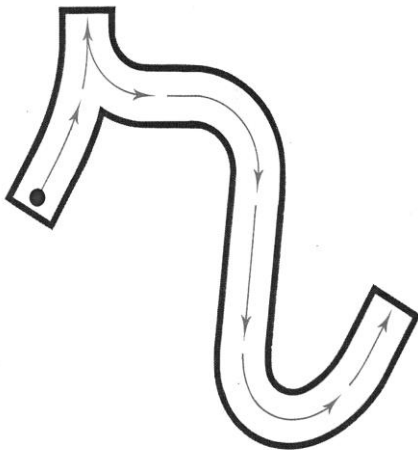
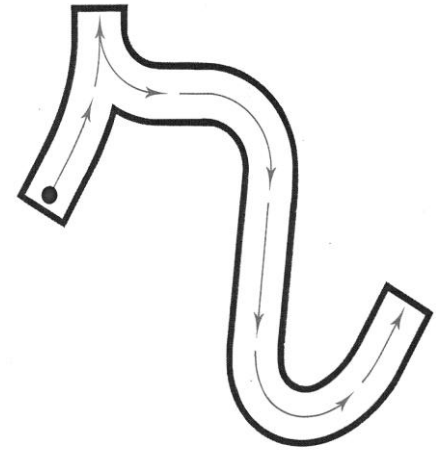
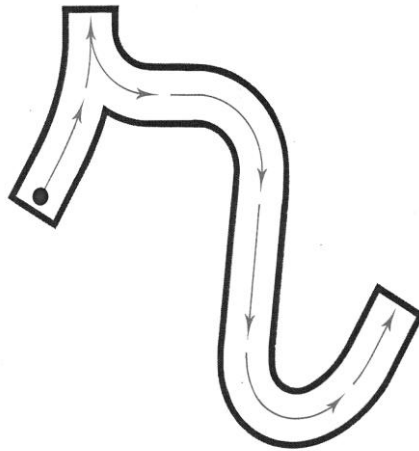
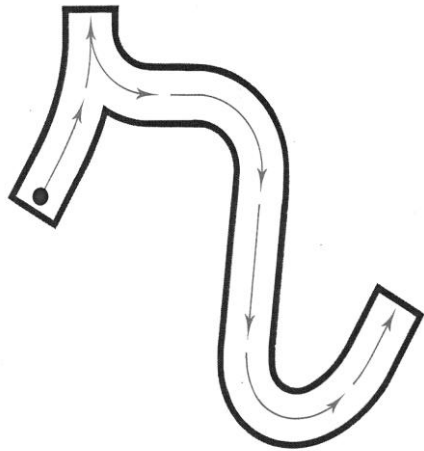

Nombre _____

Fecha _____

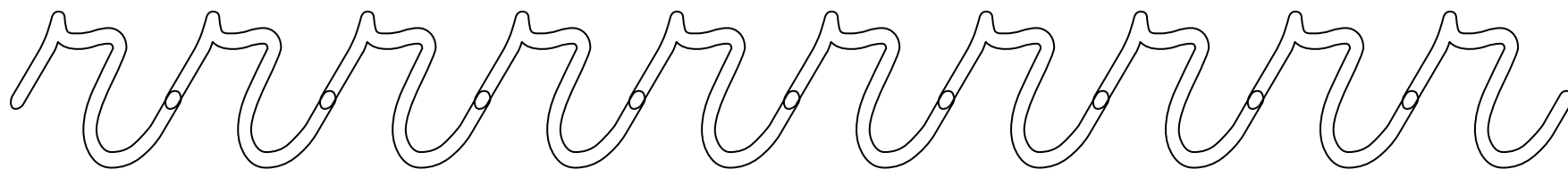
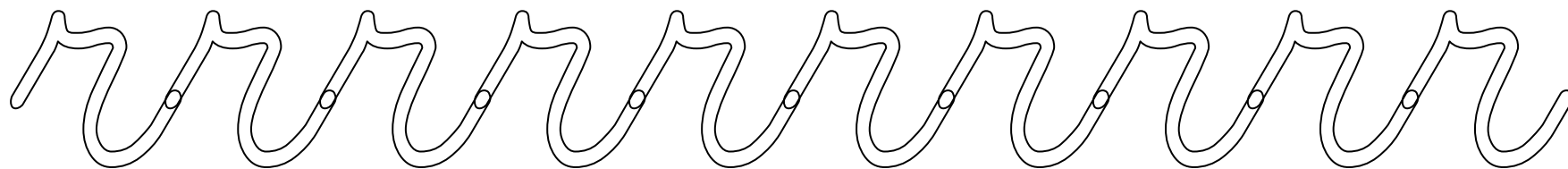
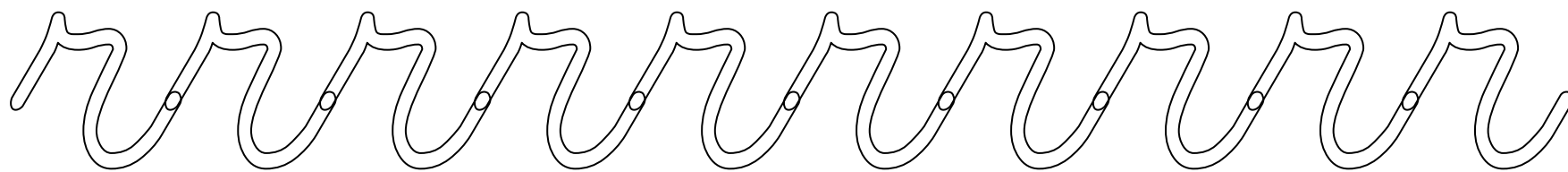

Nombre _____

Fecha _____

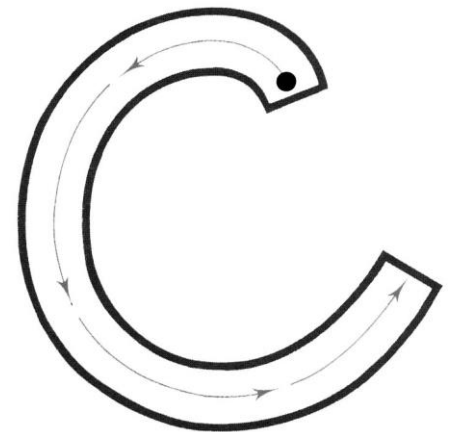
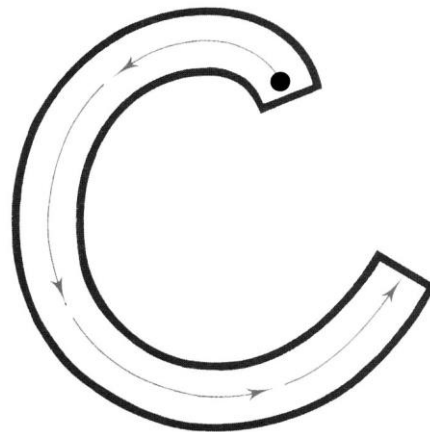
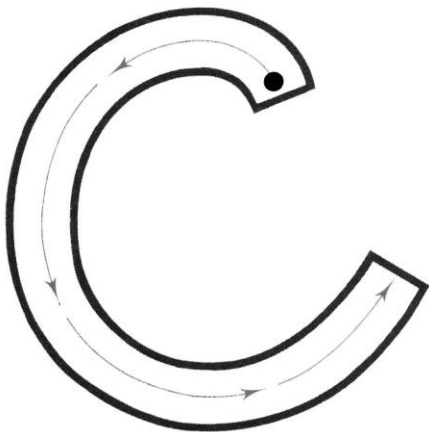
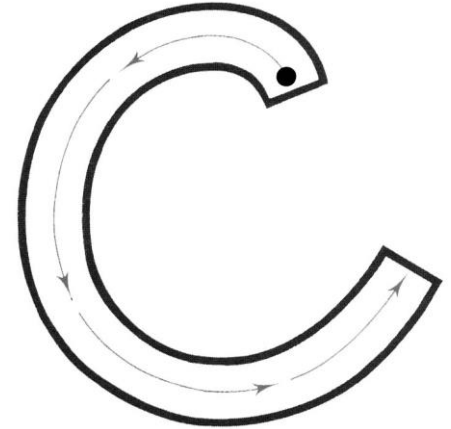
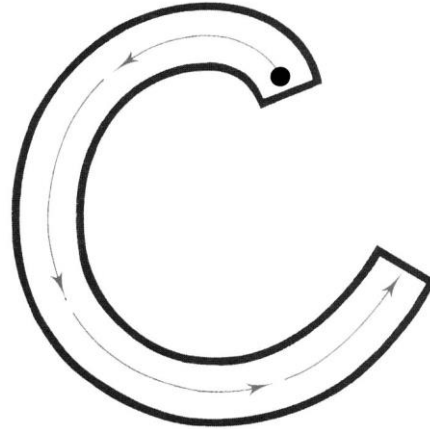
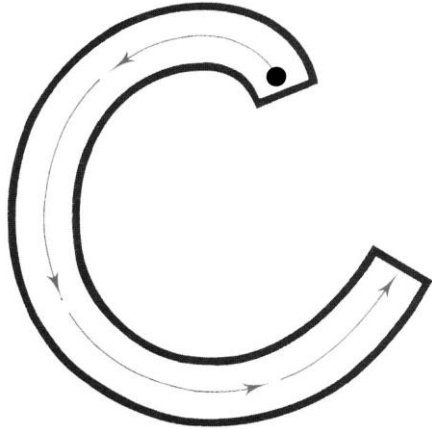

Nombre _____

Fecha _____

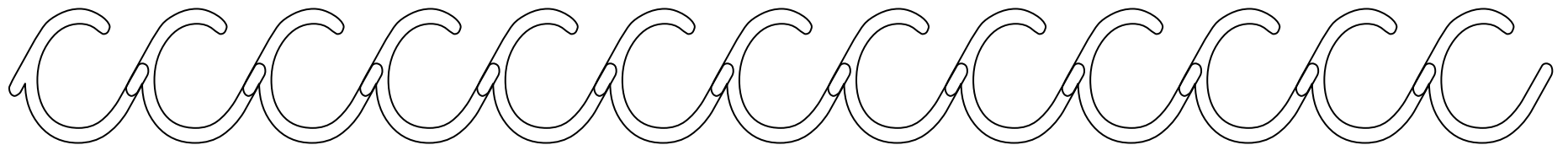
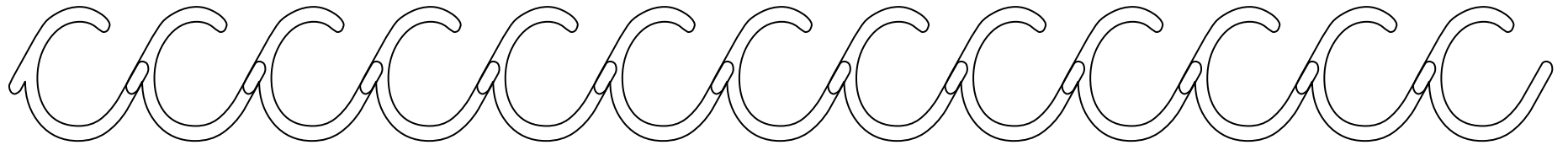
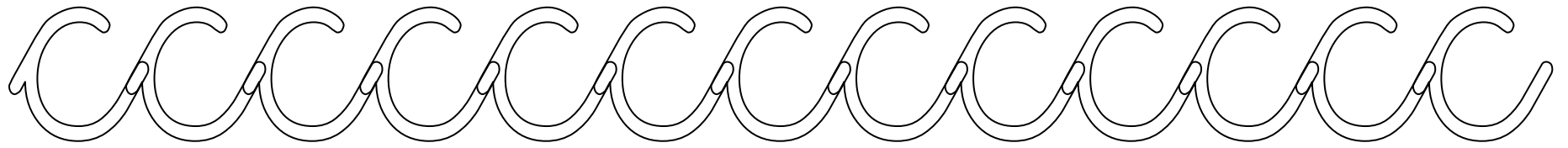

Nombre _____

Fecha _____

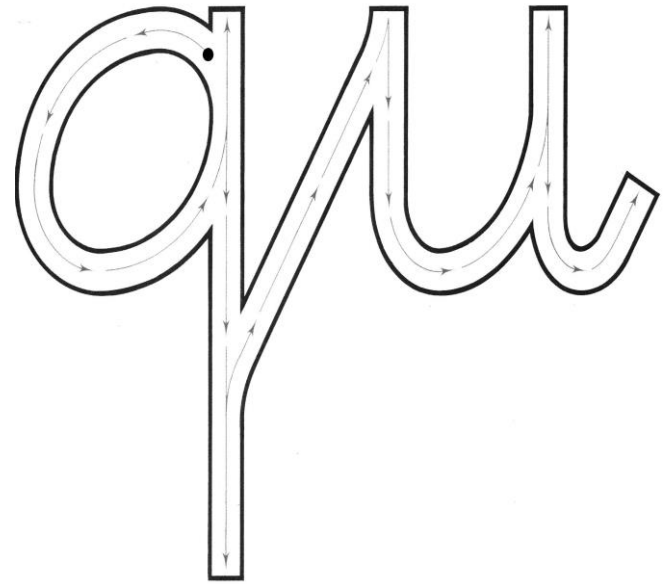
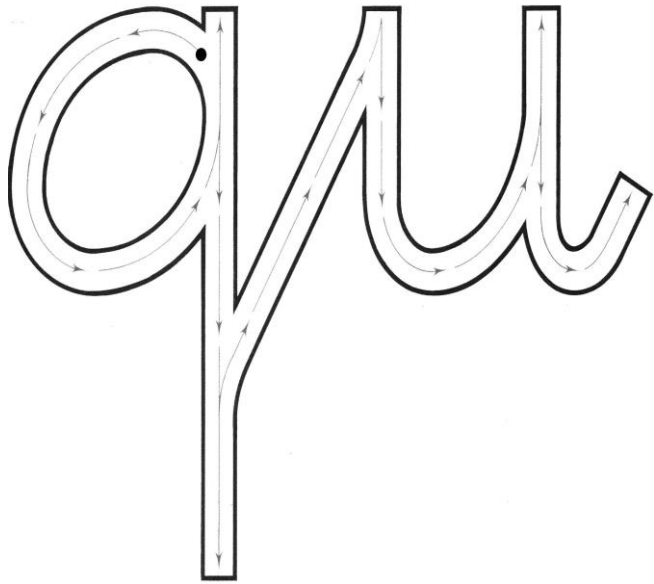

Nombre _____

Fecha _____

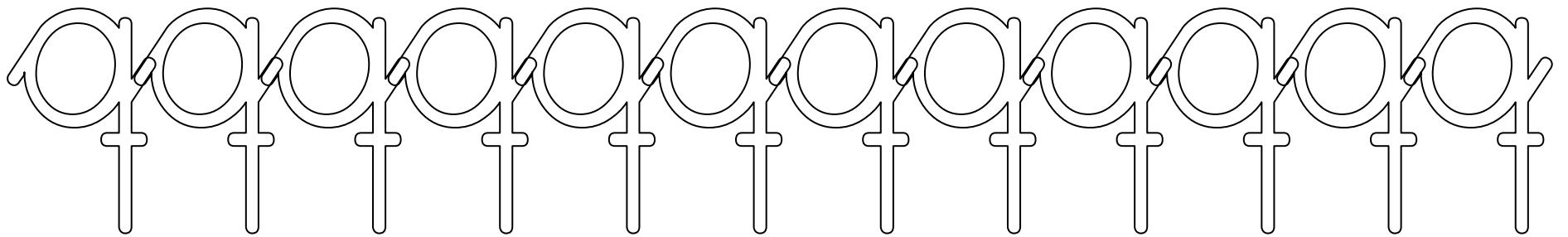
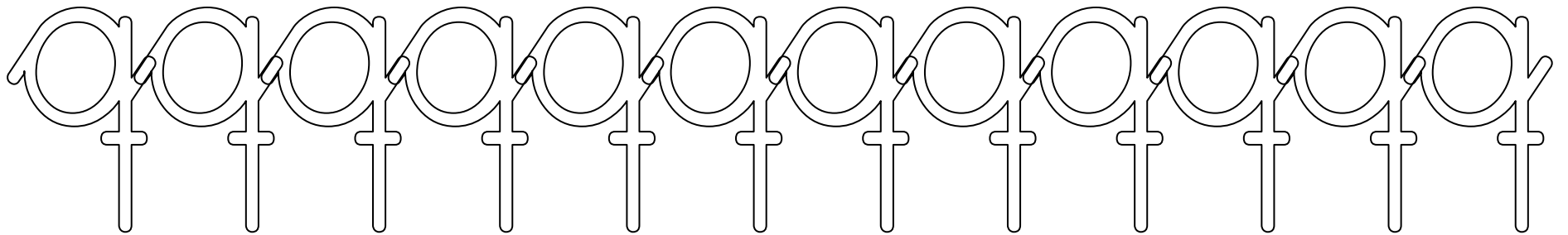
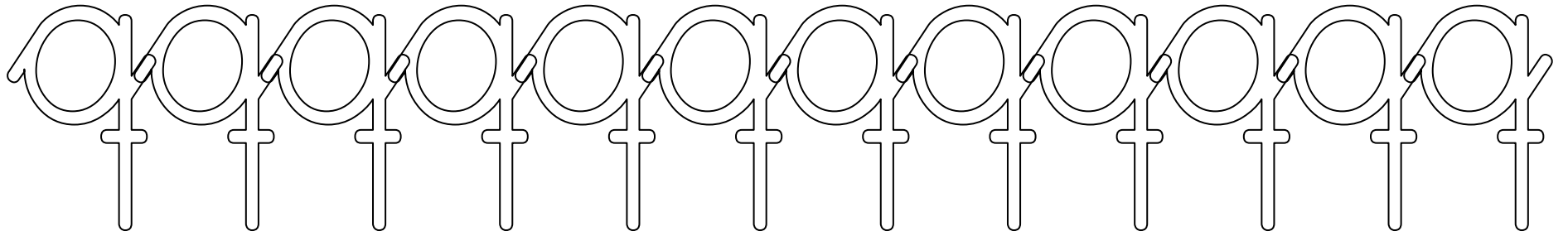

Nombre _____

Fecha _____

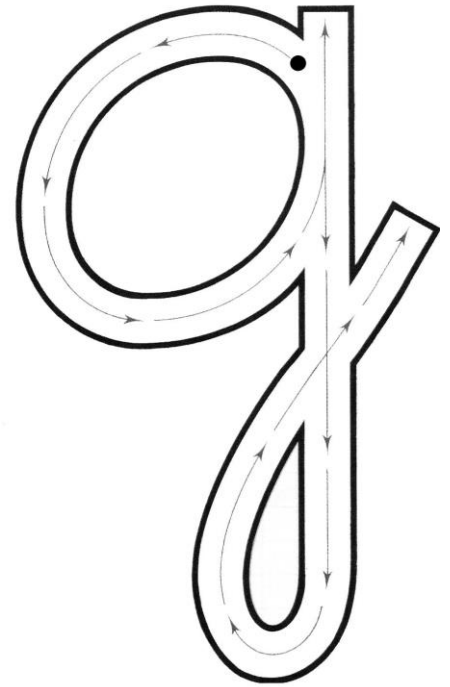
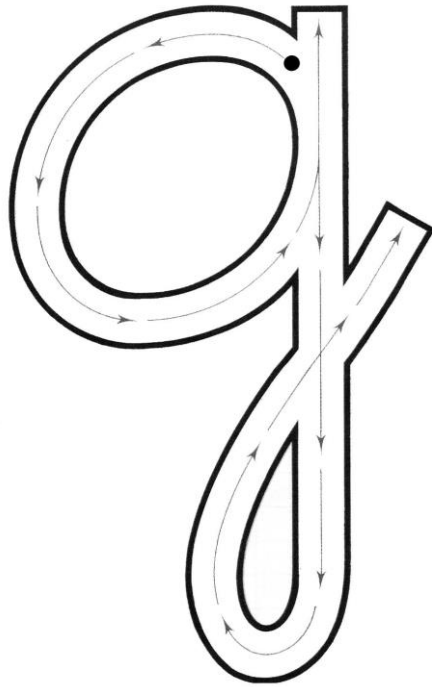

Nombre _____

Fecha _____

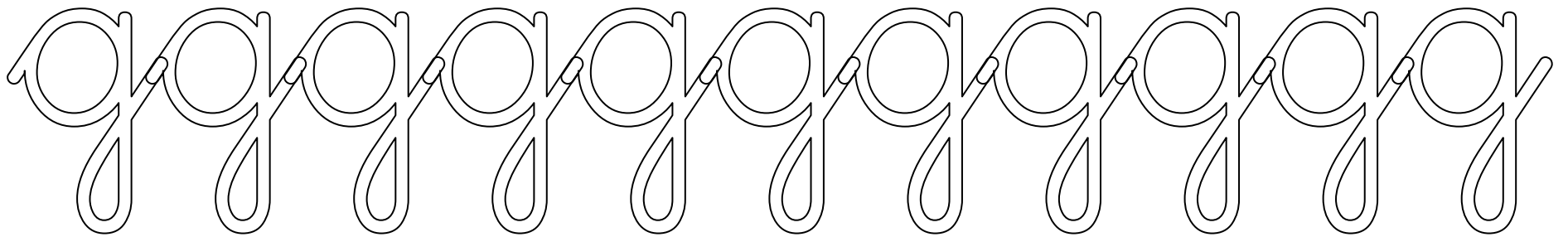
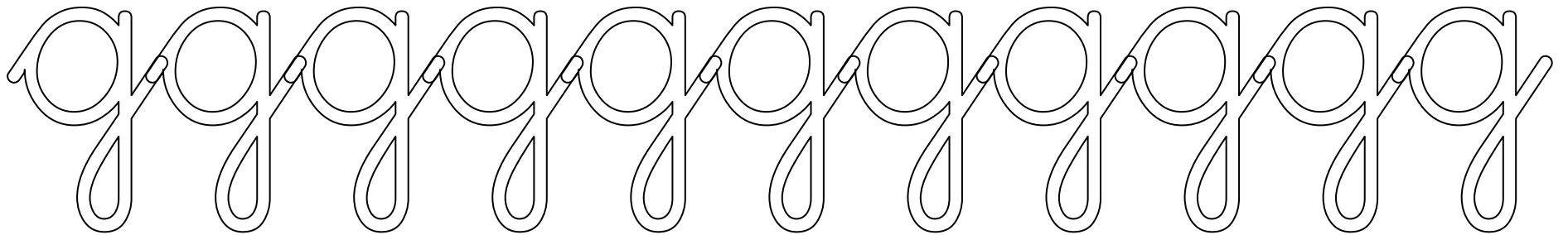
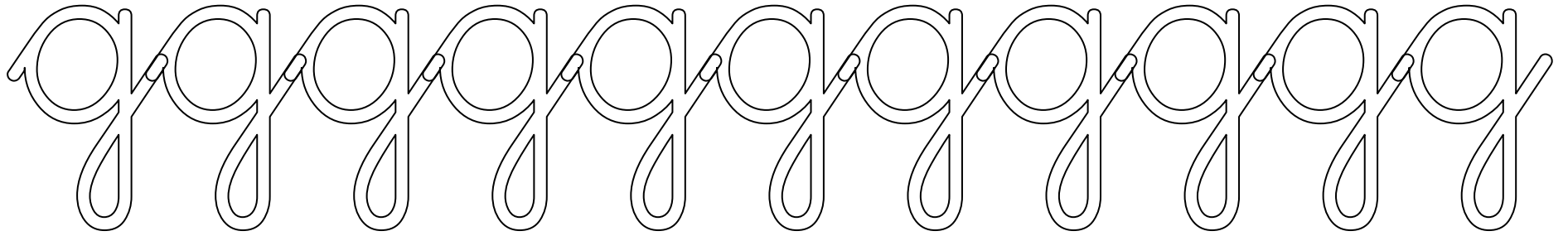

Nombre _____

Fecha _____

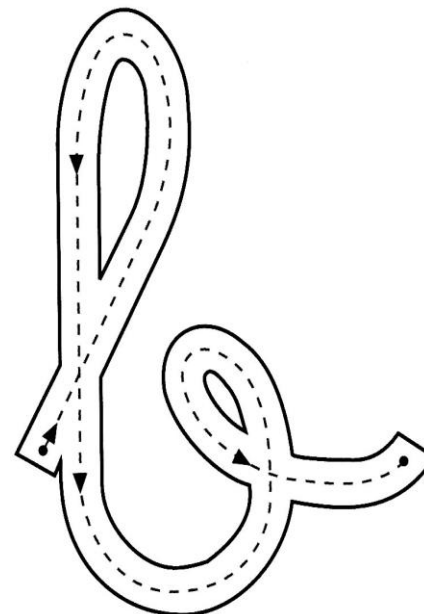
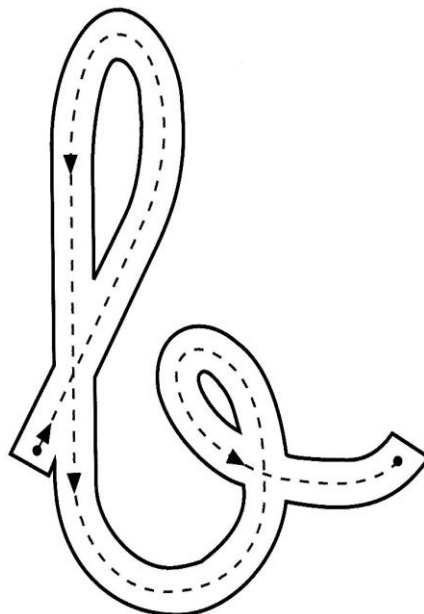
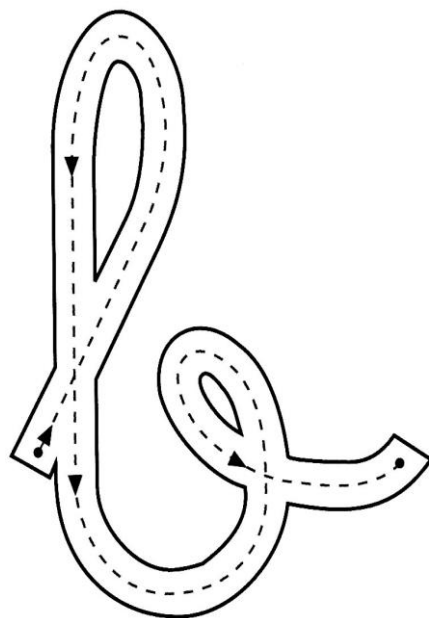

Nombre _____

Fecha _____

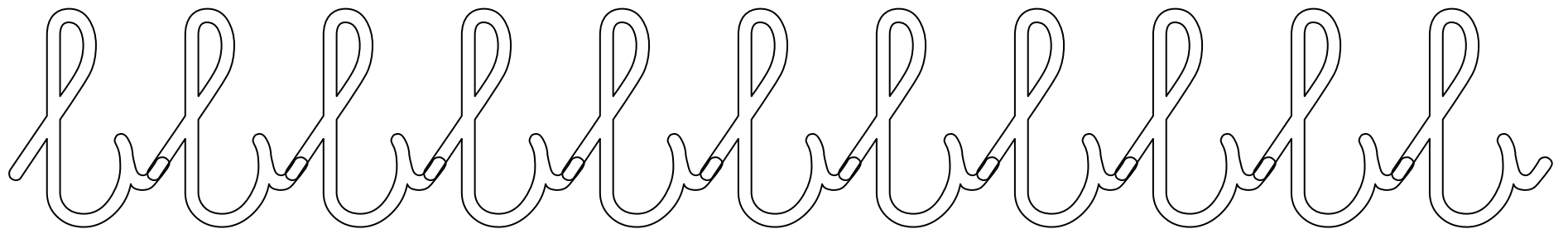
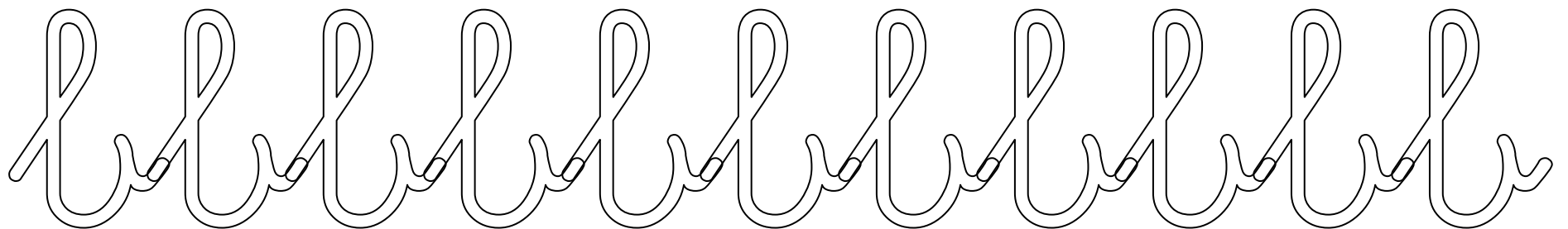
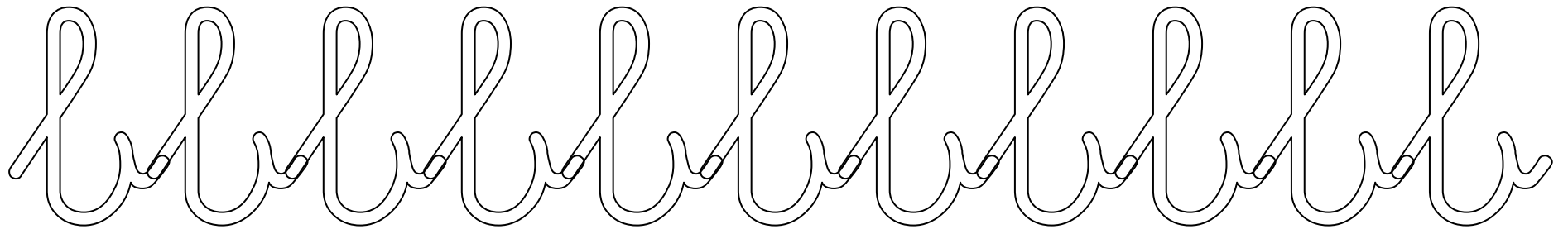

Nombre _____

Fecha _____

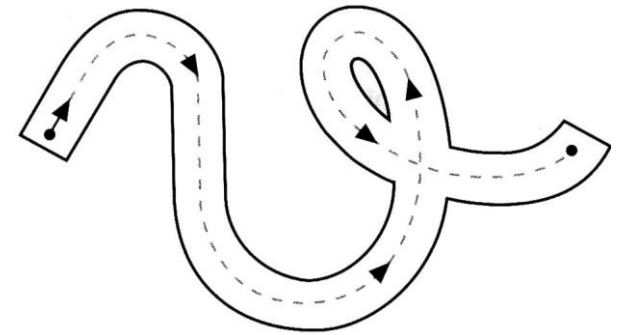
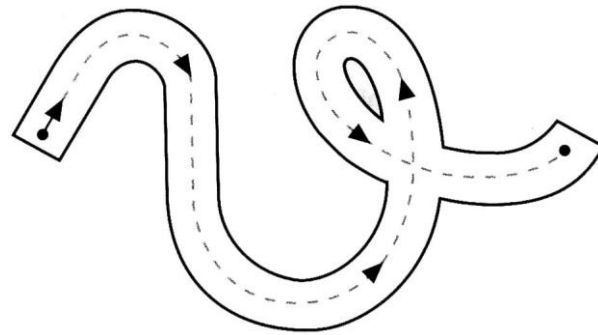
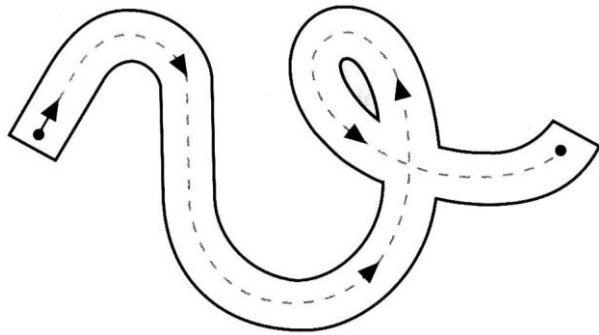
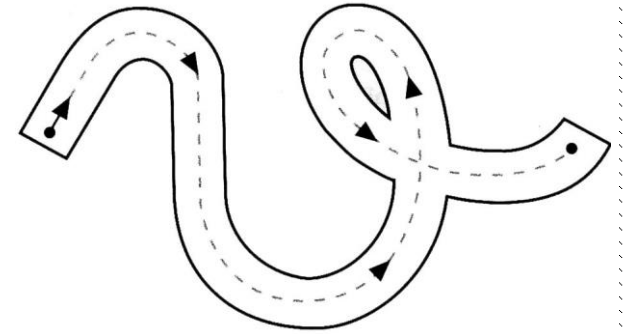
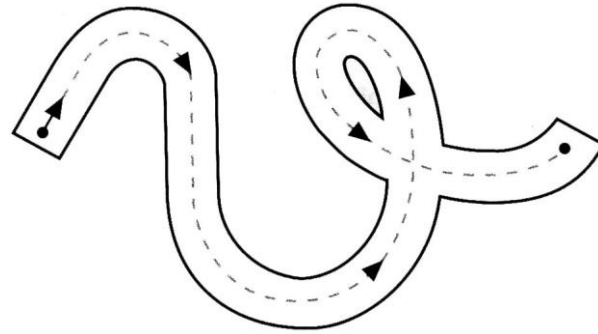
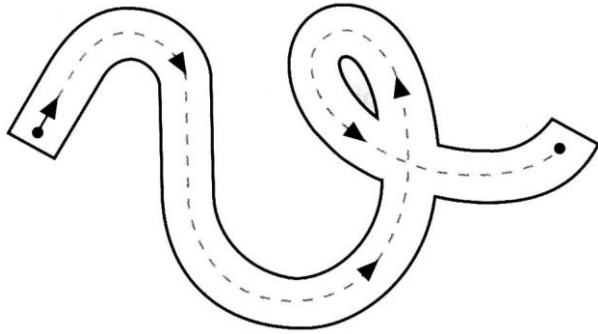

Nombre _____

Fecha _____

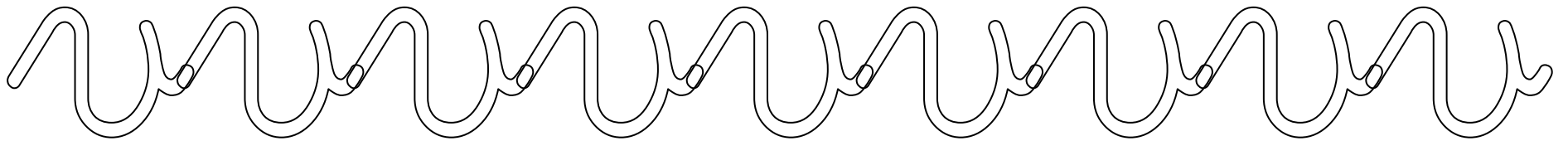
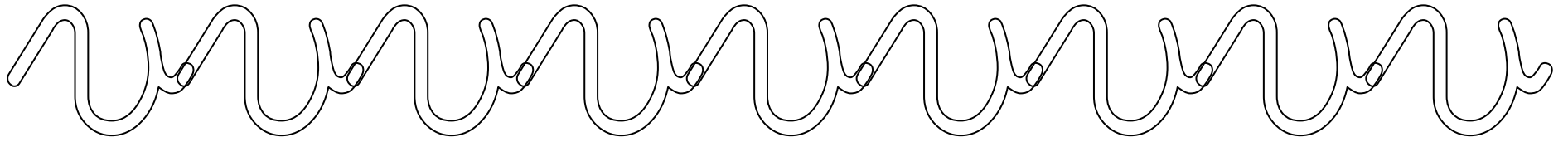
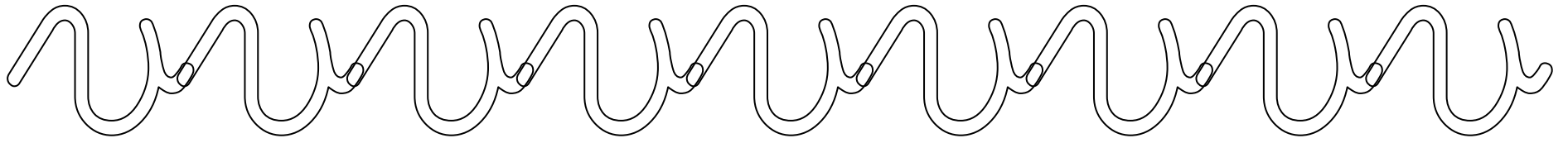

Nombre _____

Fecha _____



Nombre _____

Fecha _____

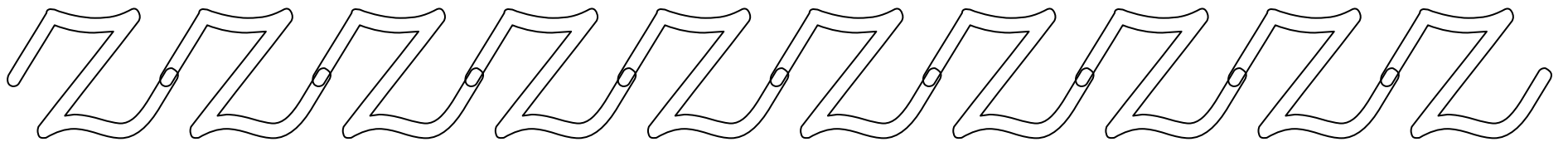
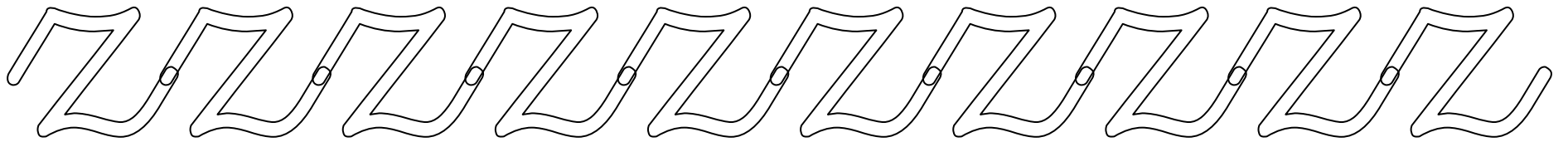
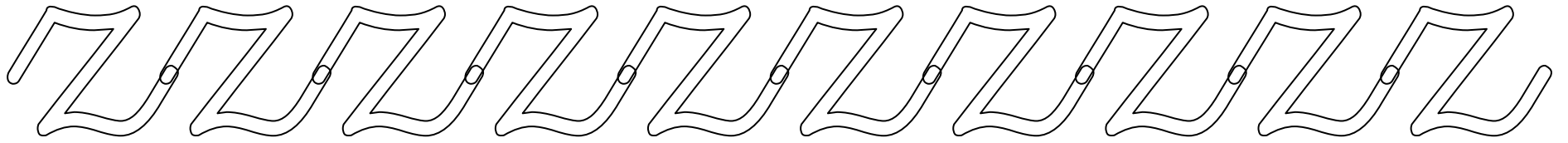

Nombre _____

Fecha _____

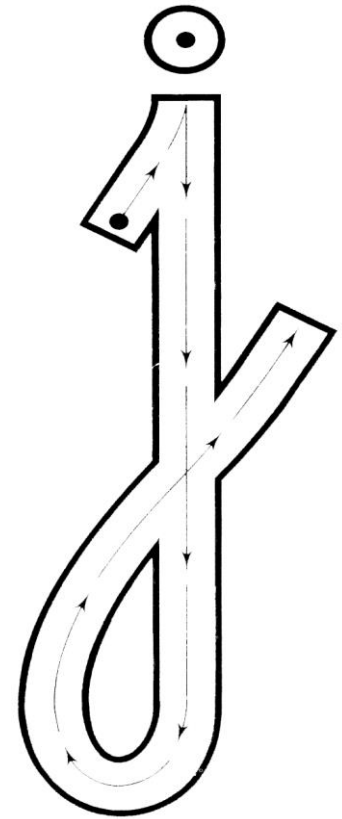
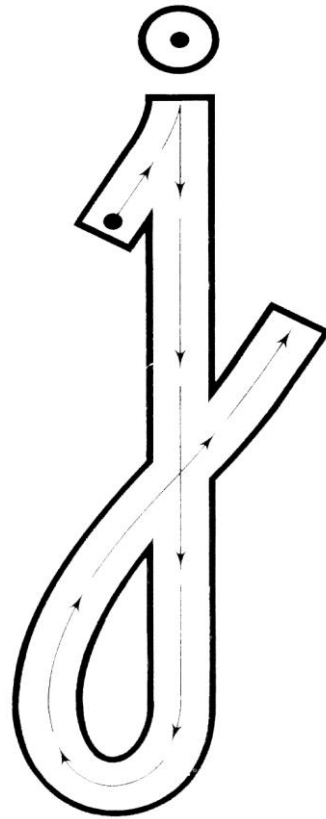
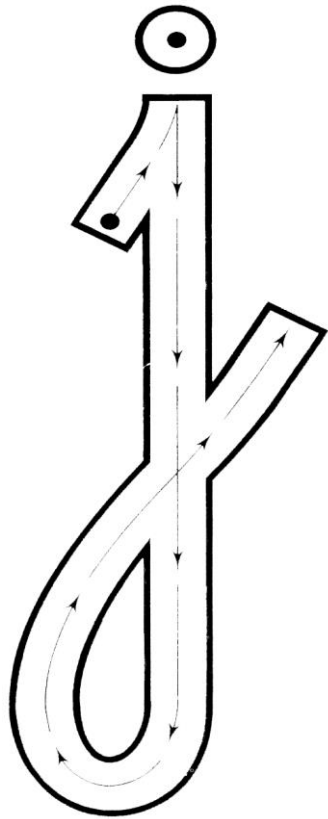

Nombre _____

Fecha _____

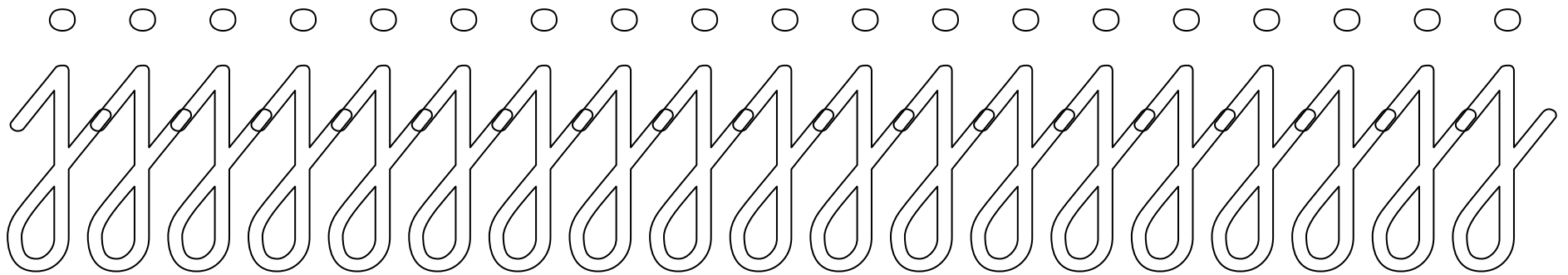
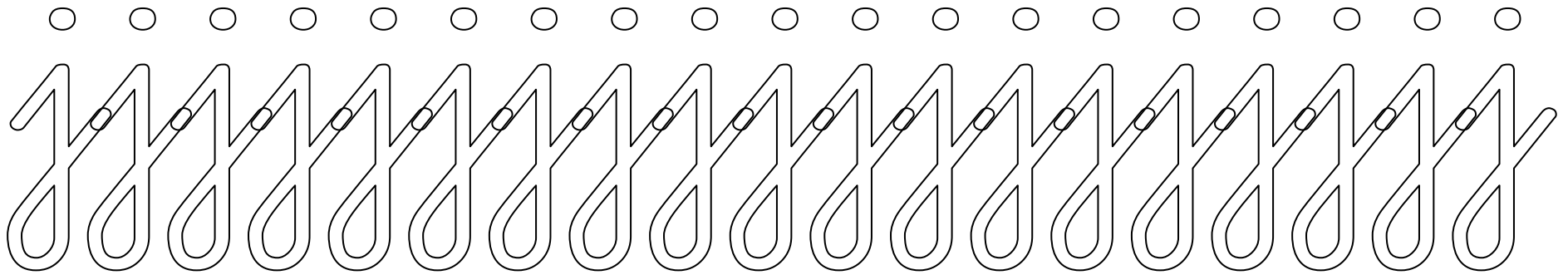
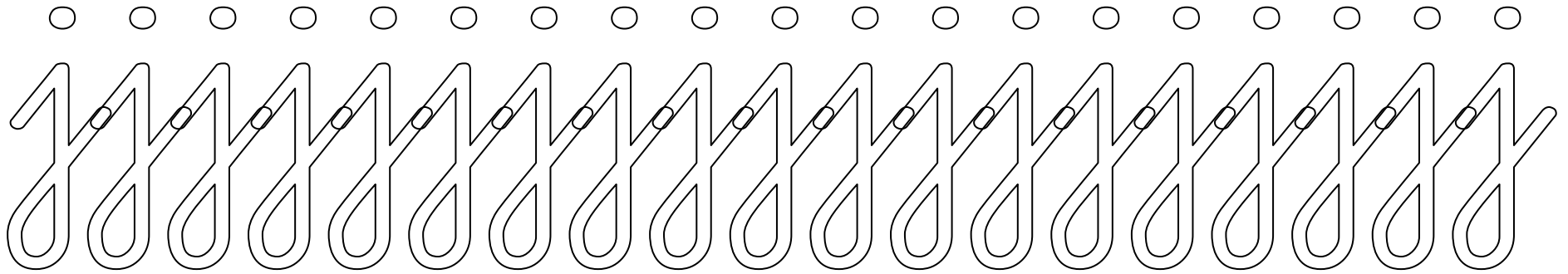

Nombre _____

Fecha _____

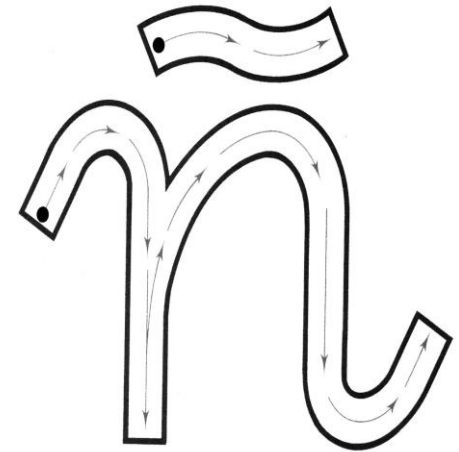
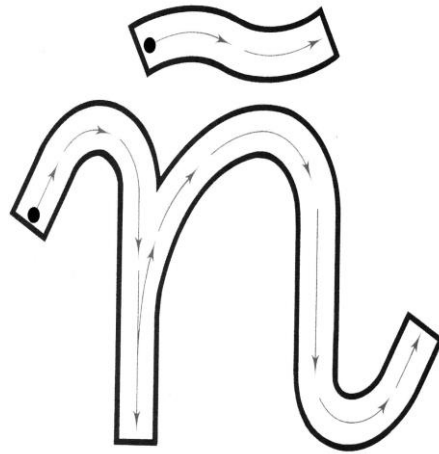
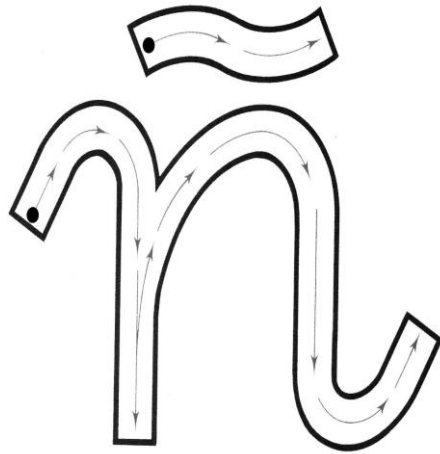

Nombre _____

Fecha _____

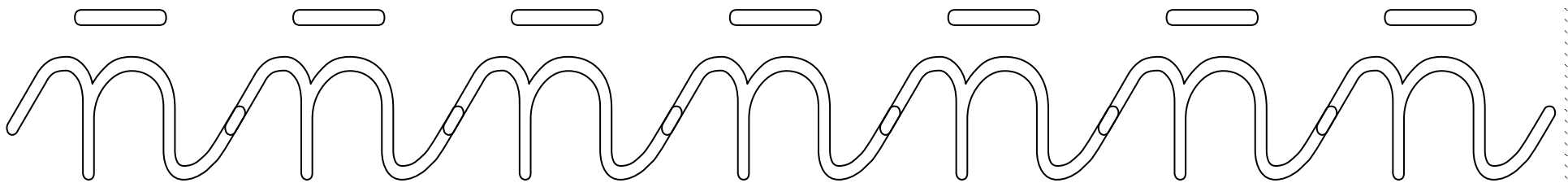
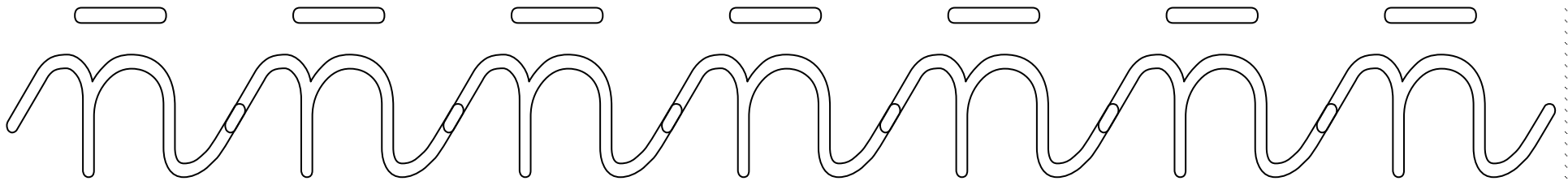
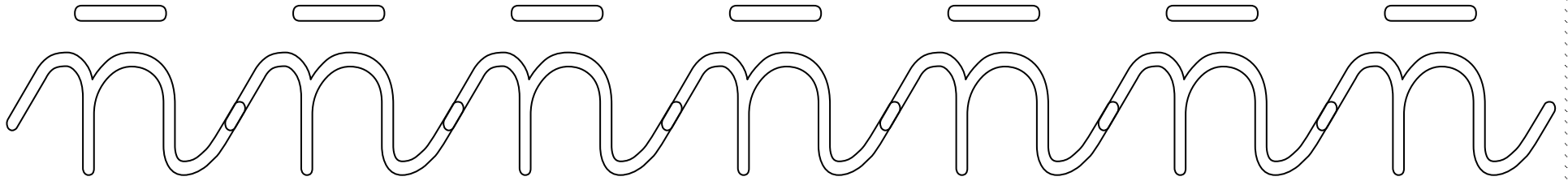

Nombre _____

Fecha _____

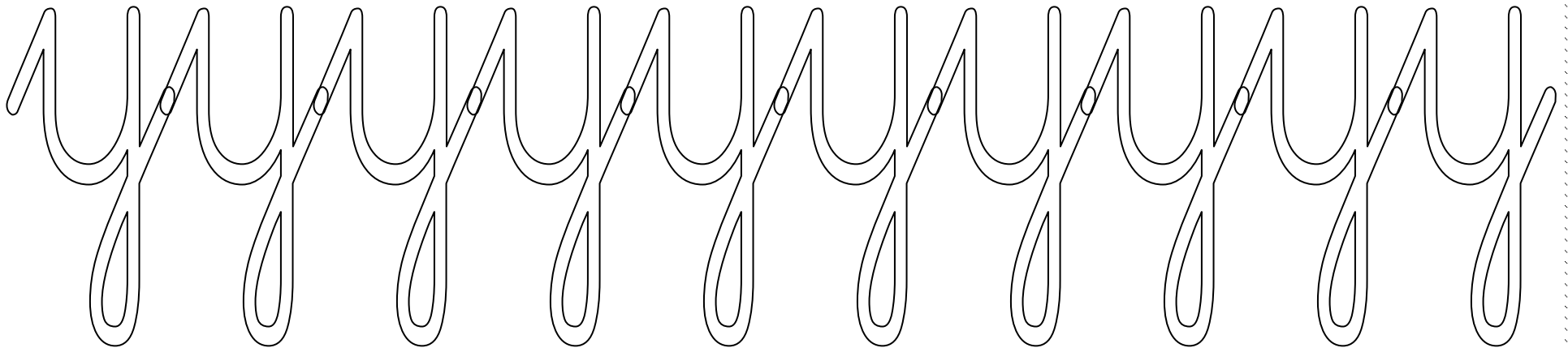
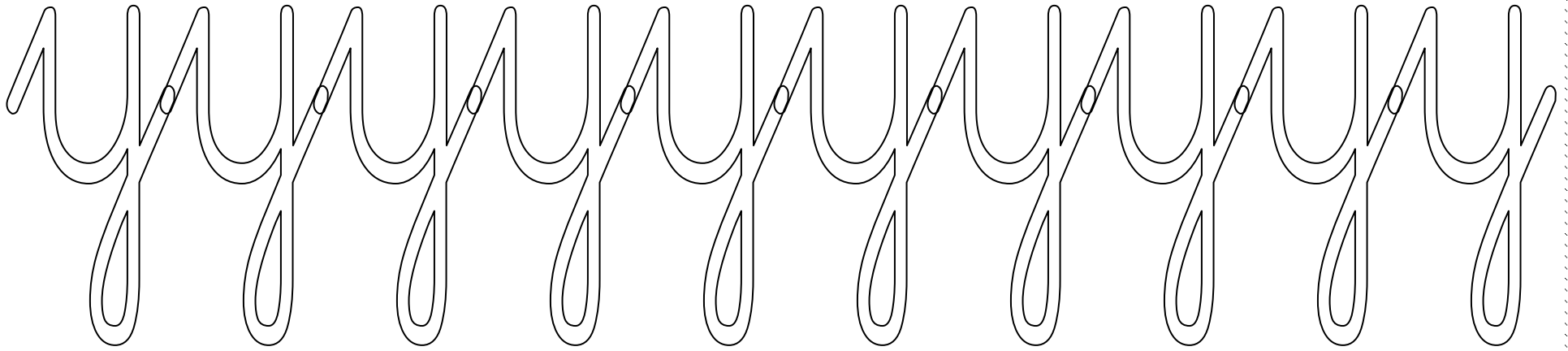

Nombre _____

Fecha _____

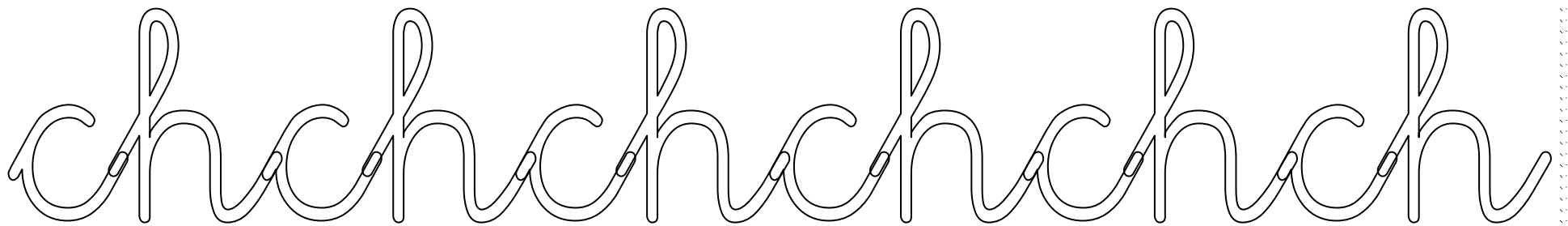
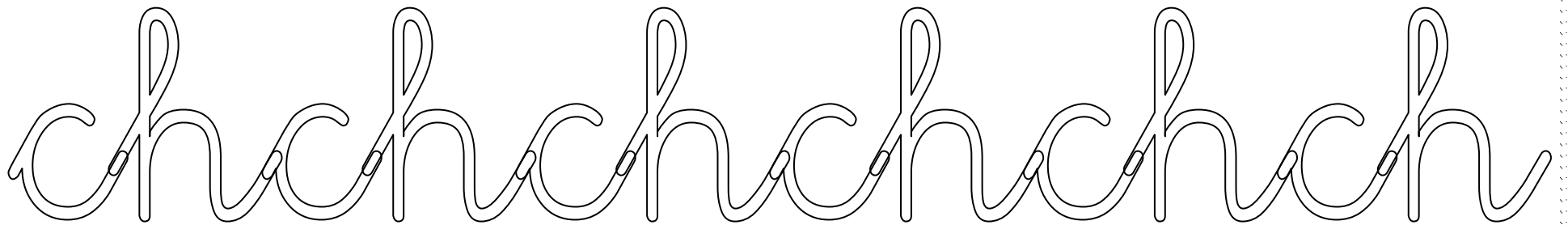
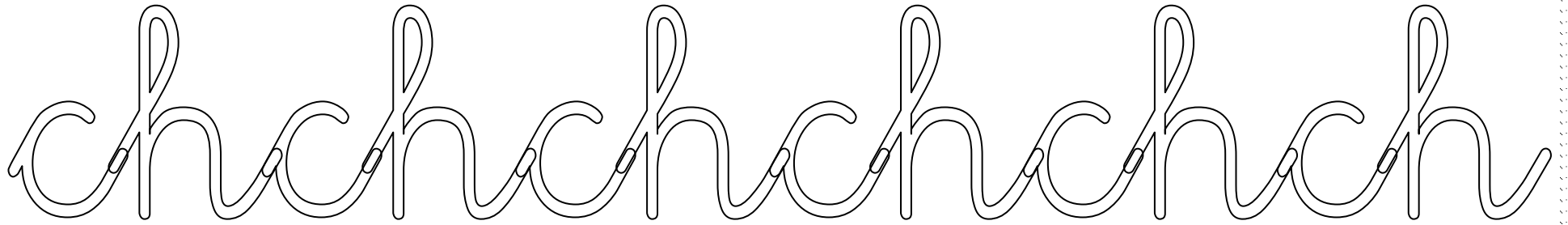

Nombre _____

Fecha _____

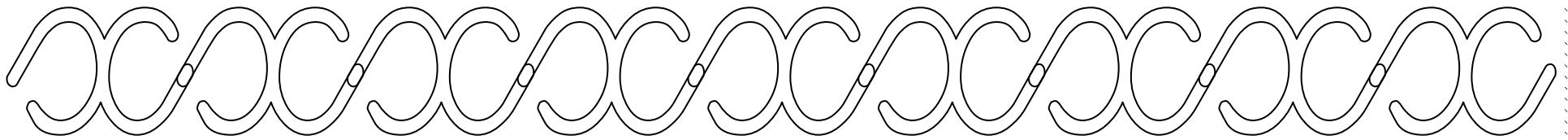
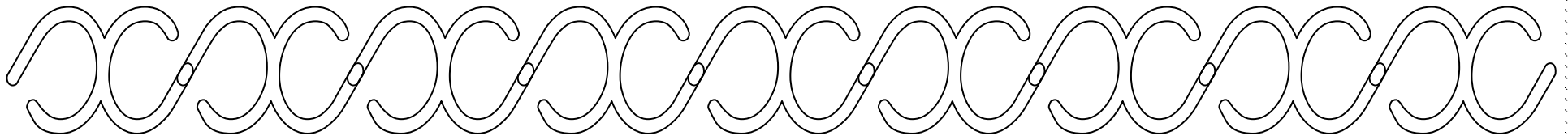
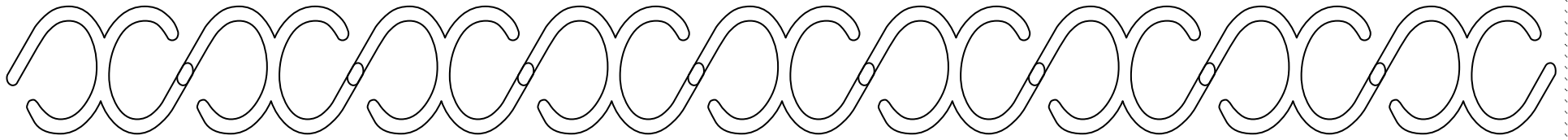

Nombre _____

Fecha _____

